

Magelis Smart 15"

User Manual

07/2010

The information provided in this documentation contains general descriptions and/or technical characteristics of the performance of the products contained herein. This documentation is not intended as a substitute for and is not to be used for determining suitability or reliability of these products for specific user applications. It is the duty of any such user or integrator to perform the appropriate and complete risk analysis, evaluation and testing of the products with respect to the relevant specific application or use thereof. Neither Schneider Electric nor any of its affiliates or subsidiaries shall be responsible or liable for misuse of the information contained herein. If you have any suggestions for improvements or amendments or have found errors in this publication, please notify us.

No part of this document may be reproduced in any form or by any means, electronic or mechanical, including photocopying, without express written permission of Schneider Electric.

All pertinent state, regional, and local safety regulations must be observed when installing and using this product. For reasons of safety and to help ensure compliance with documented system data, only the manufacturer should perform repairs to components.

When devices are used for applications with technical safety requirements, the relevant instructions must be followed.

Failure to use Schneider Electric software or approved software with our hardware products may result in injury, harm, or improper operating results.

Failure to observe this information can result in injury or equipment damage.

© 2010 Schneider Electric. All rights reserved.

Table of Contents



	Safety Information	5
	About the Book	7
Part I	General Overview	13
Chapter 1	Important Information	15
	Federal Communications Commission Radio Frequency Interference Statement - For U.S.A.	16
	Qualified Personnel	17
	Safety Information for the UK	18
	Certifications and Standards	20
	European (CE) Compliance	22
	Hazardous Location Installations - For USA and Canada	23
Chapter 2	Physical Overview	29
	Package Contents	30
	Smart 15" Unit Description	32
	Interface Specification	38
Chapter 3	Characteristics	43
	Characteristics of the Smart 15"	44
	Flash Disk Characteristics	47
	Environmental Characteristics	48
Chapter 4	Dimensions/Assembly	49
	Dimensions	50
	Panel Mounting	53
	Preparing to Install the 15" Smart	55
Part II	Implementation	61
Chapter 5	Getting Started	63
	First Power-up	63
Chapter 6	Main Power Connection	67
	Grounding	68
	Installing the Power Switch Cover	71
	Connecting the DC Power Cord	73
	Connecting the AC Power Cord	77
	Control Drawing of the USB outlet on the Magelis iPC	79

Chapter 7	Configuration of the BIOS	81
	Accessing the BIOS	81
Chapter 8	Hardware Modifications	85
	Before Modifications	86
	Removing the Smart Unit's Cover	89
	Smart 15" Internal View	90
	USB Front Face	91
	PCMCIA Card Installation	93
	Compact Flash (CF) Card Installation and Removal	96
	USB Cable Clamp Attachment/Removal	99
Part III	Installation	103
Chapter 9	Connections to PLCs	105
	Connection to PLCs	105
Chapter 10	System Monitoring	109
	System Monitor Overview	110
	System Monitor Property	117
	System Monitor Interface	121
Chapter 11	Maintenance	129
	Reinstallation Procedure	130
	Regular Cleaning and Maintenance	133
Chapter 12	Troubleshooting	139
	Troubleshooting	139
Part IV	Appendices	143
Chapter 13	Accessories	145
	Accessories for the Smart 15"	145
Index	147

Safety Information

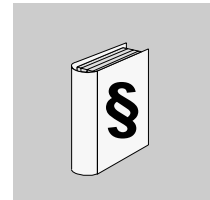

Important Information

NOTICE

Read these instructions carefully, and look at the equipment to become familiar with the device before trying to install, operate, or maintain it. The following special messages may appear throughout this documentation or on the equipment to warn of potential hazards or to call attention to information that clarifies or simplifies a procedure.



The addition of this symbol to a Danger or Warning safety label indicates that an electrical hazard exists, which will result in personal injury if the instructions are not followed.



This is the safety alert symbol. It is used to alert you to potential personal injury hazards. Obey all safety messages that follow this symbol to avoid possible injury or death.

DANGER

DANGER indicates an imminently hazardous situation which, if not avoided, **will result in** death or serious injury.

WARNING

WARNING indicates a potentially hazardous situation which, if not avoided, **can result in** death or serious injury.

 **CAUTION**

CAUTION indicates a potentially hazardous situation which, if not avoided, **can result in** minor or moderate injury.

CAUTION

CAUTION, used without the safety alert symbol, indicates a potentially hazardous situation which, if not avoided, **can result in** equipment damage.

PLEASE NOTE

Electrical equipment should be installed, operated, serviced, and maintained only by qualified personnel. No responsibility is assumed by Schneider Electric for any consequences arising out of the use of this material.

A qualified person is one who has skills and knowledge related to the construction and operation of electrical equipment and the installation, and has received safety training to recognize and avoid the hazards involved.

About the Book

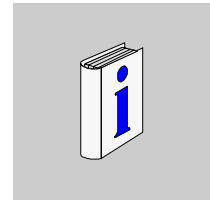

At a Glance

Document Scope

This manual describes the configuration and usage of the Smart 15" from the Magelis industrial PC range.

This computer is designed to operate in an industrial environment and features the very latest technologies.

The Magelis Smart 15" computer is a standalone product.

The product references are:

- HMIPSC7DE03 - Smart 15" DC
 - 24 Vdc
 - 15" XGA Touch screen
 - 1 GHz processor
 - 1024 MB RAM
 - 2 GB Compact Flash card
 - Windows® XPe
 - Client application pre-installed
- HMIPSC7AE03 - Smart 15" AC
 - 100...240 Vac
 - 15" XGA Touch screen
 - 1 GHz processor
 - 1024 MB RAM
 - 2 GB Compact Flash card
 - Windows® XPe
 - Client application pre-installed
- HMIGTW7353 - Graphic Terminal
 - 24 Vdc
 - 15" XGA Touch screen
 - 1 GHz processor
 - 1024 MB RAM
 - 2 GB Compact Flash card

- Windows® XPe
- Client application and Run-Time Vijeo Designer pre-installed
- HMIPSF7DP03 - Smart+ 15" DC
 - 24 Vdc
 - 15" XGA Touch screen
 - 1 GHz processor
 - 1024 MB RAM
 - 15 GB Flash disk
 - Windows® XPpro
- HMIPSF7AP*3 - Smart+ 15" AC
 - *The different letters indicate the different software bundles.
 - 100...240 Vac
 - 15" XGA Touch screen
 - 1 GHz processor
 - 1024 MB RAM
 - 15 GB Flash disk
 - Windows® XPpro

The characteristics of the Smart 15" are detailed in Characteristics (*see page 43*)

Part Number Description

Your product may have a Part Number not included in the enclosed User Manual. The commercial Part Number mentioned in the User Manual are those at the introduction of the product range. New part Numbers may be added during the life cycle of the product range. The new products are similar to products described in the User Manual but with changes, such as storage device size or type, memory size or bundled application software. The differences from the initial part numbers are indicated below:

	HMI		PS		F		•		A		•		•		•
Reference	1		2		3		4		5		6		7		8

Reference Number	Character Name	Possible Value
1	Part number radical	HMI NOTE: No change over product range
2	Product Type	PS = Smart NOTE: No change over product range
3	Storage	C = Compact Flash F = Flash Disk H = HDD

Reference Number	Character Name	Possible Value
4	Screen size	4 = 8.4" 6 = 12" 7 = 15" 9 = 19"
5	Power Supply	A = AC D = DC
6	Operating System	E = XP Embedded P = XP Pro 7 = Seven • = Other Operating System
7	Bundled Software	0 = None F = Vijeo Citect Run Time 500 I/O Full L = Vijeo Citect Run Time 1200 I/O Lite • = Other application software
8	Hardware iteration	0 = Initial 1 = First 2 = Second etc.

NOTE: All instructions applicable to the enclosed product and all safety precautions must be observed.

Validity Note

This documentation is valid for Magelis Smart 15”.

The technical characteristics of the device(s) described in this manual also appear online. To access this information online:

Step	Action
1	Go to www.schneider-electric.com
2	In the Search box on the home page, type a model number. Do not type any blank spaces in the model number. To get information on a grouping similar modules, you can use the characters **; do not use dots or xx's.
3	Under All , click Products → Product Datasheets and select the model number that interests you.
4	To save or print a data sheet as a .pdf file, click Export to PDF .

The characteristics presented in this manual should be the same as those that appear online. In line with our policy of constant improvement we may revise content over time to improve clarity and accuracy. In the event that you see a difference between the manual and online information, use the online information as your reference.

Registered Trademarks

PL7, Vijeo Designer, Vijeo Citect and Unity are registered trademarks of Schneider Electric.

Microsoft® and Windows® are registered trademarks of Microsoft Corporation.

Intel®, Celeron®, and Pentium® are registered trademarks of Intel Corporation.

IBM® is a registered trademark of International Business Machines Corporation.

Related Documents

Title of Documentation	Reference Number
Installation Guide for Magelis Industrial PC and Terminals	35012221
Vijeo Designer Tutorial	35007035
NEMA ICS 1.1	–
Magelis Industrial PC and Terminals - Readme	35012220

You can download these technical publications and other technical information from our website at www.schneider-electric.com.

Product Related Information

Some Smart 15" units are certified for use in Class I, Division 2 hazardous locations as defined in UL 1604, ANSI/ISA 12.12.01 or CSA C22.2 N° 213. Observe the following:

DANGER

HAZARD OF ELECTRIC SHOCK, EXPLOSION OR ARC FLASH

- Remove all power from the device before removing any covers or elements of the system, and prior to installing or removing any accessories, hardware, or cables.
- Unplug the power cable from both the Smart unit and the power supply.
- Always use a properly rated voltage sensing device to confirm power is off.
- Replace and secure all covers or elements of the system before applying power to the unit.
- Use only the specified voltage when operating the Smart 15". The AC unit is designed to use 100...240 Vac input. The DC unit is designed to use 23...25 Vdc. Always check whether your device is AC or DC powered before applying power.

Failure to follow these instructions will result in death or serious injury.

WARNING

LOSS OF CONTROL

- The designer of any control scheme must consider the potential failure modes of control paths and, for certain critical control functions, provide a means to achieve a safe state during and after a path failure. Examples of critical control functions are emergency stop and overtravel stop.
- Separate or redundant control paths must be provided for critical control functions.
- System control paths may include communication links. Consideration must be given to the implications of unanticipated transmission delays or failures of the link.(1)
- Each implementation of a Magelis Smart 15" must be individually and thoroughly tested for proper operation before being placed into service.

Failure to follow these instructions can result in death, serious injury, or equipment damage.

(1) For additional information, refer to *NEMA ICS 1.1 (latest edition), "Safety Guidelines for the Application, Installation, and Maintenance of Solid State Control"* and to *NEMA ICS 7.1 (latest edition), "Safety Standards for Construction and Guide for Selection, Installation and Operation of Adjustable-Speed Drive Systems"* or their equipment governing your particular location.

NOTE: The Smart 15" is a highly configurable device and is not based on a real-time operating system. Changes to the software and settings of the following must be considered new implementations as discussed in the message above. Examples of such changes include:

- System BIOS
- System Monitor (*see page 109*)
- Operating system
- Installed hardware
- Installed software

WARNING

UNINTENDED EQUIPMENT OPERATION

Use only Schneider Electric software with the devices described in this manual.

Failure to follow these instructions can result in death, serious injury, or equipment damage.

User Comments

We welcome your comments about this document. You can reach us by e-mail at techcomm@schneider-electric.com.

General Overview

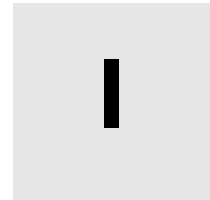

Subject of this Part

This part provides an overview of the Magelis Smart 15" product.

What's in this Part?

This part contains the following chapters:

Chapter	Chapter Name	Page
1	Important Information	15
2	Physical Overview	29
3	Characteristics	43
4	Dimensions/Assembly	49

Important Information



General

This chapter describes the safety aspects which are specific to the operation of the Smart 15".

What's in this Chapter?

This chapter contains the following topics:

Topic	Page
Federal Communications Commission Radio Frequency Interference Statement - For U.S.A.	16
Qualified Personnel	17
Safety Information for the UK	18
Certifications and Standards	20
European (CE) Compliance	22
Hazardous Location Installations - For USA and Canada	23

Federal Communications Commission Radio Frequency Interference Statement - For U.S.A.

FCC Radio Interference Information

This equipment has been tested and found to comply with the Federal Communications Commission (FCC) limits for a Class A digital device, pursuant to Part 15 of the FCC Rules. These limits are designed to provide reasonable protection against harmful interference in a residential installation. This equipment generates, uses, and can radiate radio frequency energy and, if not installed and used in accordance with the instructions, may cause or be subject to interference with radio communications. To minimize the possibility of electromagnetic interference in your application, observe the following two rules:

- Install and operate the Smart 15" in such a manner that it does not radiate sufficient electromagnetic energy to cause interference in nearby devices.
- Install and test the Smart 15" to ensure that the electromagnetic energy generated by nearby devices does not interfere with the Smart's operation.

WARNING

ELECTROMAGNETIC / RADIO INTERFERENCE

Electromagnetic radiation may disrupt the Smart's operations, leading to unintended equipment operation. If electromagnetic interference is detected:

- Increase the distance between the Smart 15" and the interfering equipment.
- Reorient the Smart 15" and the interfering equipment.
- Reroute power and communication lines to the Smart 15" and the interfering equipment.
- Connect the Smart 15" and the interfering equipment to different power supplies.
- Always use shielded cables when connecting the Smart 15" to a peripheral device or another computer.

Failure to follow these instructions can result in death, serious injury, or equipment damage.

Qualified Personnel

General

You must only permit qualified personnel to install, operate, and maintain these products. A qualified person is one who has skills and knowledge related to the constructions and operation of this electrical equipment and the installations, and has received safety training to recognize and avoid the hazards involved. Refer to the most current release of NFPA 70E®, Standard for Electrical Safety in the Workplace, for electrical safety training requirements. Examples of qualified personnel may include:

- at the application design level, engineering department personnel who are familiar with automation safety concepts (for example, a design engineer)
- at the equipment implementation level, personnel who are familiar with the installation, connection and commissioning of automation equipment (for example, an installation assembly or cabling engineer or a commissioning technician)
- at the operation level, personnel who are experienced in the use and control of automation and computing equipment (for example, an operator)
- as far as preventive or corrective maintenance is concerned, personnel trained and qualified in regulating or repairing automatic and computing devices (for example, an operating technician or an after-sales service technician, etc.)

Safety Information for the UK

Earthing and Wiring

WARNING

UNGROUNDING EQUIPMENT

- This apparatus must be earthed.
- Use a three-pin plug with a standard three-pin power point.
- Use only three-core extension cords.

Failure to follow these instructions can result in death, serious injury, or equipment damage.

WARNING

IMPROPER WIRING

Wire the equipment as described below:

- Green and Yellow: Earth.
- Blue: Neutral.
- Brown: Live.
- The Green and Yellow wire must be connected to the terminal in the plug marked by the letter E or by the safety earth symbols colored Green, or Green and Yellow.
- The blue wire must be connected to the terminal which is marked by the letter N or colored Black.
- The brown wire must be connected to the terminal which is marked with the letter L or colored Red.

Failure to follow these instructions can result in death, serious injury, or equipment damage.

NOTE: The fact that the equipment operates satisfactorily does not imply that the power point is earthed. If you have any doubt about the effective earthing or wiring of the power point, consult a qualified electrician. Incorrectly wired power cords are a major cause of fatalities.

WARNING

INCOMPATIBLE POWER SYSTEM

Do not connect this equipment to an isolation transformer power system:

- An isolation transformer system is a system having no reference between live parts and Earth; the exposed conductive parts of the device frame and enclosure are earthed.
- An isolation transformer system is not permitted where the computer is directly connected to public supply systems in the UK.

Failure to follow these instructions can result in death, serious injury, or equipment damage.

Certifications and Standards

Agency Certifications

Schneider Electric submitted this product for independent testing and qualification by third-party listing agencies. These agencies have certified this product as meeting the following standards.

- Underwriters Laboratories Inc., UL 508 or CSA C22.2 N° 142, Industrial Control Equipment
- Underwriters Laboratories Inc., UL 1604, ANSI/ISA 12.12.01 or CSA C22.2 N° 213, Electrical Equipment for Use in Class I, Division 2 Hazardous (Classified) Locations
- These products were submitted for GOST certification. Please refer to marking on the products.
- ATEX certification for DC products by INERIS is ongoing, please refer to product label.
- DC products are designed to comply with Merchant Navy rules (refer to Schneider Electric web site for installation guidelines).

For detailed information contact your local distributor and see the catalog and marking on the product.

Compliance Standards

Schneider Electric tested this product for compliance with the following compulsory standards.

United States:

- Federal Communications Commission, FCC Part 15
- Underwriters Laboratories Inc., UL 60950, Information Technology Equipment

Canada:

- Canadian Standards Association, specification C22.2, No.142, Process Control Equipment

Europe: CE

- Directive 2006/95/EC (Low Voltage)
Directive 2004/108/EC (EMC)
- Programmable Controllers: EN/IEC 61131-2 (Ed 3)
- EMI: EN55011 (Group 1, Class A) / IEC/EN 61000-3-2, IEC/EN 61000-6-4
- EMS: EN 61000-6-2
- IEC/EN 60950, Information Technology Equipment

Australia:

- Standard AS/NZS CISPR11 (C-Tick N998)

Qualification Standards

Schneider Electric voluntarily tested this product to additional standards. The additional tests performed, and the standards under which the tests were conducted, are specifically identified in Environmental Characteristics (*see page 48*).

Hazardous Substances

This product is compliant with:

- WEEE, Directive 2002/96/EC
- RoHS, Directive 2002/95/EC
- RoHS China, Standard SJ/T 11363-2006

European (CE) Compliance

CE Compliance Note

The products described in this manual comply with the European Directives concerning Electromagnetic Compatibility and Low Voltage (CE marking) when used as specified in the relevant documentation, in applications for which they are specifically intended, and in connection with approved third-party products.

Hazardous Location Installations - For USA and Canada

General

Schneider Automation designed the Smart 15" with the intention of meeting the requirements of Class I, Division 2 hazardous location applications. Division 2 locations are those locations where ignitable concentrations of flammable substances are normally confined, prevented by ventilation, or present in an adjacent Class I, Division 1 location, but where an abnormal situation might result in intermittent exposure to such ignitable concentrations.

While the Smart 15" is a non-incendiary device under UL 1604, ANSI/ISA 12.12.01 or CSA C22.2 N° 213, it is not designed for, and should never be used within a Division 1 (normally hazardous) location.

All HMIPSC7*3, HMIGTW7353 and HMIPSF7***3 devices with appropriate labeling are suitable for use in Class I, Division 2, Groups A, B, C, and D hazardous locations or in non-hazardous locations. Before installing or using your Smart 15", confirm that the UL 1604, ANSI/ISA 12.12.01 or CSA C22.2 N° 213 certification appears on the product labeling.**

NOTE: Some Smart 15" devices are not yet rated as suitable for use in hazardous locations. Always use your product in conformance with the product labeling and this manual.

DANGER

EXPLOSION HAZARD

- Do not use your Smart 15" device in hazardous environments or locations other than Class I, Division 2, Groups A, B, C, and D.
- Always confirm that your Smart 15" device is suitable for use in hazardous locations by checking that the UL 1604, ANSI/ISA 12.12.01 or CSA C22.2 N° 213 certification appears on the product labeling.
- Do not install any Schneider Electric or OEM components, equipment, or accessories unless these have also been qualified as suitable for use in Class I, Division 2, Groups A, B, C, and D locations.
- In addition, confirm that any PCI controller cards have a temperature code (T-code) of T4, and are suitable for an ambient temperature range of +0° C to +50° C (32° F to 122° F).
- Do not attempt to install, operate, modify, maintain, service, or otherwise alter the Smart 15" except as permitted in this manual. Unpermitted actions may impair the unit's suitability for Class I, Division 2 operation.

Failure to follow these instructions will result in death or serious injury.

DANGER

EXPLOSION HAZARD

- Always confirm the UL 1604, ANSI/ISA 12.12.01 or CSA C22.2 N° 213 hazardous location rating of your device before installing or using it in a hazardous location.
- To apply or remove the supply power from a Smart 15" device installed in a Class I, Division 2 hazardous location, you must either:
 - Use a switch located outside the hazardous environment, or;
 - Use a switch certified for Class I, Division 1 operation inside the hazardous area.
- Do not connect or disconnect any cables or wires while the circuit is live unless the area is known to be free of ignitable concentrations of vapors, gases, and other flammable or combustible materials. This applies to all connections including power, ground, serial, parallel, and network connections.
- Never use unshielded / ungrounded cables in hazardous locations.
- Use only non-incendiary USB devices (*see page 79*).
- When enclosed, keep enclosure doors and openings closed at all times to avoid the accumulation of foreign matter inside the workstation.

Failure to follow these instructions will result in death or serious injury.

DANGER

HAZARD OF ELECTRIC SHOCK, EXPLOSION OR ARC FLASH

- Remove all power from the device before removing any covers or elements of the system, and prior to installing or removing any accessories, hardware, or cables.
- Always use a properly rated voltage sensing device to confirm power is off.
- Unplug the power cable from both the Smart unit and the power supply.
- Replace and secure all covers or elements of the system before applying power to the unit.
- Use only the specified voltage when operating the Smart 15". The AC unit is designed to use 100...240 Vac input. The DC unit is designed to use 23...25 Vdc. Always check whether your device is AC or DC powered before applying power.

Failure to follow these instructions will result in death or serious injury.

Ensure that the product is properly rated for the location. If the intended location does not presently have a Class, Division and Group rating, then users should consult the appropriate authorities having jurisdiction in order to determine the correct rating for that hazardous location.

In accordance with Federal, State/Provincial, and Local regulations, all hazardous location installations should be inspected prior to use by the appropriate authority having jurisdiction. Only technically qualified personnel should install, service, and inspect these systems.

Power Switch

DANGER

HAZARD OF ELECTRIC SHOCK, EXPLOSION OR ARC FLASH

- Remove all power from the device before removing any covers or elements of the system, and prior to installing or removing any accessories, hardware, or cables.
- Always use a properly rated voltage sensing device to confirm power is off.
- Unplug the power cable from both the Smart unit and the power supply.
- Replace and secure all covers or elements of the system before applying power to the unit.
- Use only the specified voltage when operating the Smart 15". The AC unit is designed to use 100...240 Vac input. The DC unit is designed to use 23...25 Vdc. Always check whether your device is AC or DC powered before applying power.

Failure to follow these instructions will result in death or serious injury.

The amount of input power required by systems including a Smart 15" unit classifies a power switch as an incendiary device because the voltage and current across the make/break device are capable of creating a spark.

Hazardous location regulations require that a power switch rated for ordinary locations may be used if it is located in an area specified as non-hazardous.

However, limits in cable length between the workstation and the power switch may apply. Otherwise the switch must be compliant with Class I, Division 1 requirements (intrinsically safe). These switches are built in a manner that prevents the possibility of a spark when contacts are made or broken.

Use suitable UL listed and/or CSA Certified Class I, Division 1 switches in hazardous locations. These switches are available from a wide number of sources. It is the responsibility of the customer to ensure that the power switch selected for the installation has the correct hazardous locations rating for the location in which it is installed.

Cable Connections

DANGER

EXPLOSION HAZARD

- Always confirm the UL 1604, ANSI/ISA 12.12.01 or CSA C22.2 N° 213 hazardous location rating of your device before installing or using it in a hazardous location.
- To apply or remove the supply power from a Smart 15" device installed in a Class I, Division 2 hazardous location, you must either:
 - Use a switch located outside the hazardous environment, or;
 - Use a switch certified for Class I, Division 1 operation inside the hazardous area.
- Do not connect or disconnect any cables or wires while the circuit is live unless the area is known to be free of ignitable concentrations of vapors, gases, and other flammable or combustible materials. This applies to all connections including power, ground, serial, parallel, and network connections.
- Never use unshielded / ungrounded cables in hazardous locations.
- Use only non-incendiary USB devices (*see page 79*).
- When enclosed, keep enclosure doors and openings closed at all times to avoid the accumulation of foreign matter inside the workstation.

Failure to follow these instructions will result in death or serious injury.

Division 2 hazardous location regulations require that all cable connections be provided with adequate strain relief and positive interlock. Use only non-incendiary USB devices as USB connections do not provide adequate strain relief to allow the use of **incendiary peripherals** (*see page 79*). Never connect or disconnect a cable while power is applied at either end of the cable. All communication cables should include a chassis ground shield. This shield should include both copper braid and aluminum foil. The D-sub style connector housing should be a metal conductive type (e.g., molded zinc) and the ground shield braid should be well terminated directly to the connector housing. Do not use a shield drain wire.

The outer diameter of the cable must be suited to the inner diameter of the cable connector strain relief in order to ensure that a reliable degree of strain relief is maintained. Always secure the D-Sub connectors to the workstation-mating connectors via the two screws located on both sides.

Operation and Maintenance

The systems have been designed for compliance with relevant spark ignition tests. However, please note that the workstation front panel keypad switches and PS/2 connector are the only make/break components intended to be exercised by the operator in the course of operations in a hazardous location.

DANGER

EXPLOSION HAZARD

In addition to the other instructions in this manual, observe the following rules when installing the Smart 15" unit in a hazardous location:

- Wire the equipment in accordance with the National Electrical Code article 501.4 (B) for Class I, Division 2 hazardous locations.
- Install your Smart 15" unit in an enclosure suitable for the specific application. NEMA Type 4 (IP 65) enclosures are recommended even when not required by regulations.

Failure to follow these instructions will result in death or serious injury.

Physical Overview



Subject of this Chapter

This chapter provides a physical overview of the product.

What's in this Chapter?



This chapter contains the following topics:



Topic	Page
Package Contents	30
Smart 15" Unit Description	32
Interface Specification	38

Package Contents

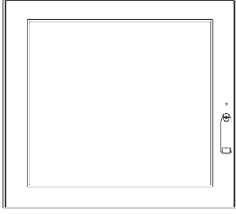
Items

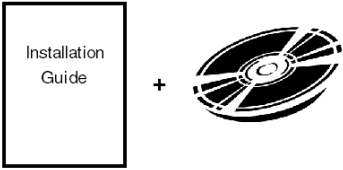
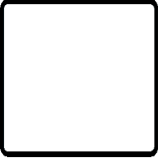
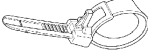
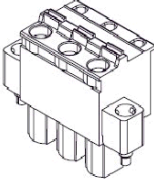
The following items are included in the Magelis Smart 15" package. Before using the unit, please confirm that all items listed here are present.

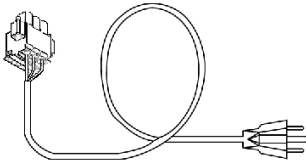
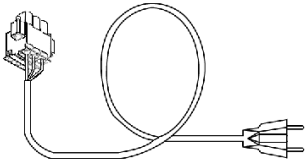
HMIPSC7***3, HMIGTW7353 and HMIPSF7***3	
Installation Fasteners (8 per set)	
CD-ROM containing the software required to reinstall the Operating System, the MS Windows EULA and the Installation Guides and User Manuals for the HMIPSC7***3, HMIGTW7353 and HMIPSF7***3.	
Installation Gasket (Installed on the main unit)	
USB Cable Clamp x 2	
DC Connector (For the Smart 15" DC only, references HMIPSC7D**3, HMIGTW7353 and HMIPSF7D**3)	

CF Card for HMIPSC7***3 and HMIGTW7353	
AC Power Cord with Terminal Block (US plug) (For the Smart 15" AC only, references HMIPSC7A**3 and HMIPSF7A**3)	
AC Power Cord with Terminal Block (EU plug) (For the Smart 15" AC only, references HMIPSC7A**3 and HMIPSF7A**3)	
AC Power switch cover (For the Smart 15" AC only, references HMIPSC7A**3 and HMIPSF7A**3)	

This unit has been carefully packed, with special attention to quality. However, should you find anything damaged or missing, please contact your local distributor immediately.

Smart 15" Unit Description

Front View

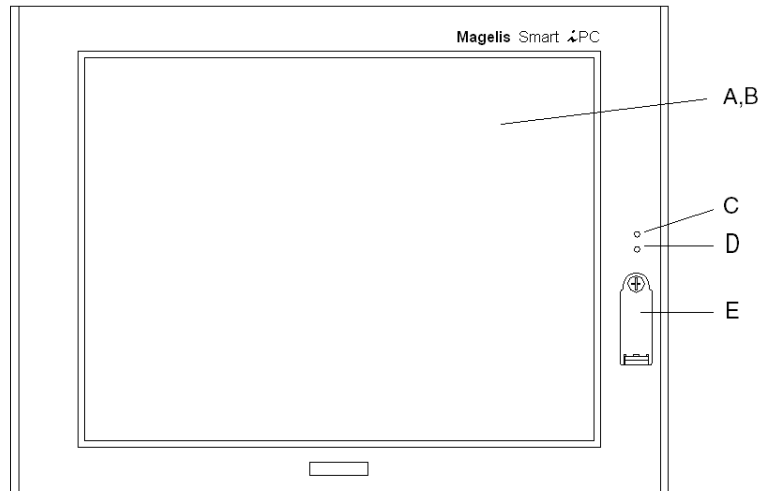

A Display

B Touch Panel

C Power LED/RAS Status Lamp

- Green Lit: Normal
- Green Blinking: System is not running (Soft OFF state (see Note below))
- Orange Lit: System Monitor Error/Touch Panel Error
- Orange/Red Blinking: Backlight Error
- Not Illuminated: Power is Off

D HDD/IDE Access Lamp

- Green Lit: Access to HDD or IDE
- Not Illuminated: No Access to HDD or IDE

E Front USB Cover

NOTE: Soft OFF: OS is shut down but the power line is still live. This is also called "S5 state". One of the merits of this state is that you can also use the "Wake on LAN" feature.

Rear View of the DC Units

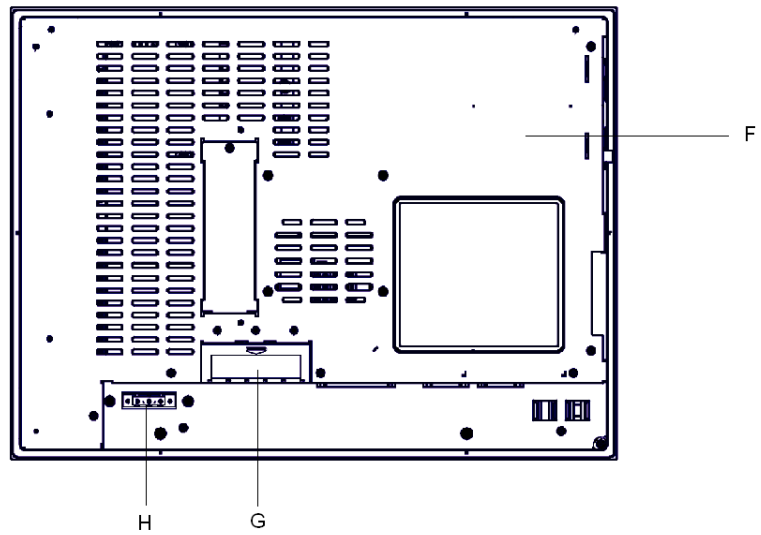

- F** Unit's Cover
- G** CF Card Interface Cover
- H** Power Connector

Rear View of the AC Units

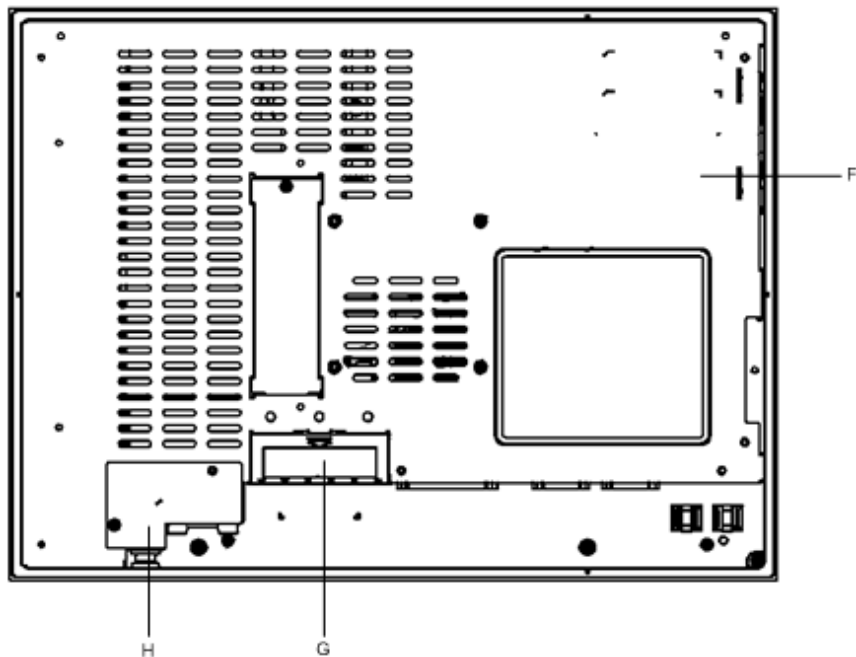

- F Unit's Cover
- G CF Card Interface Cover
- H Power Connector

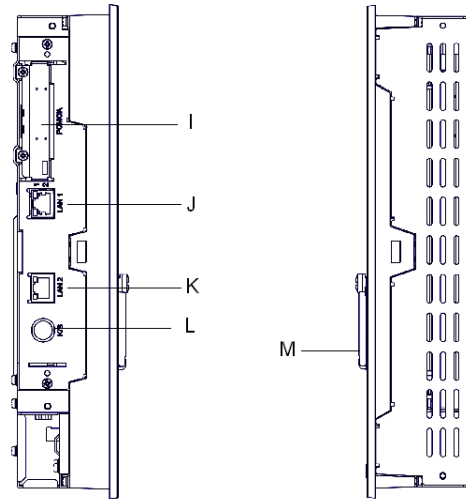
Sides View

- I** PCMCIA
- J** Ethernet LAN1 10/100Base-T (RJ45)
- K** Ethernet LAN2 10/100/1000Base-T (RJ45)
- L** PS/2 (Keyboard)
- M** Front USB Cover

Bottom View the DC Units

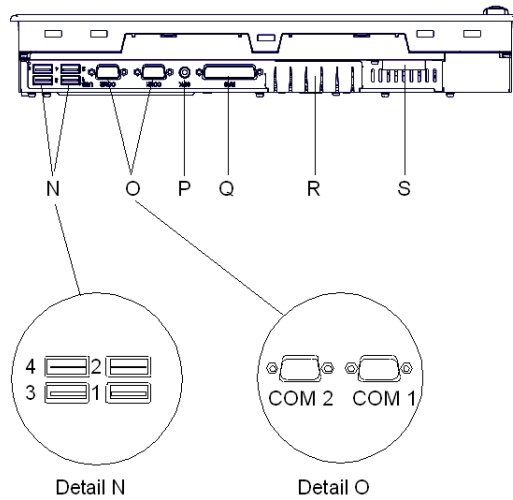

- N** USB (4 ports) (See detail N)
- O** COM 1 and COM 2 (See detail O)
- P** Speaker Out
- Q** RAS (25 pins)
- R** CF Card Interface Cover
- S** Power Connector

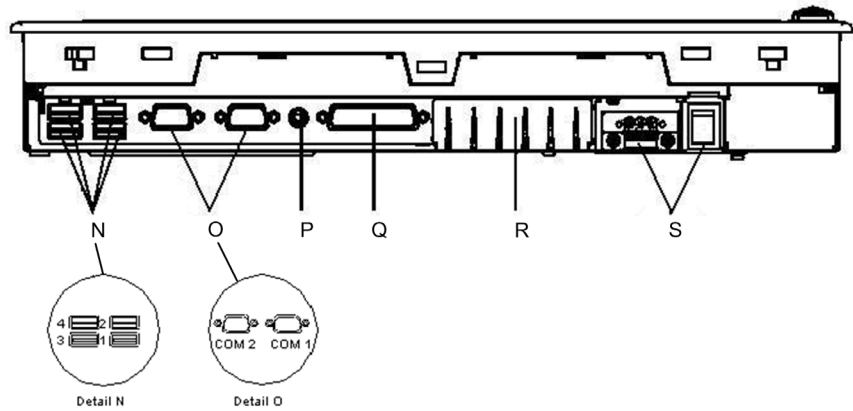
Bottom View the AC Units

- N** USB (4 ports) (See detail N)
- O** COM 1 and COM 2 (See detail O)
- P** Speaker Out
- Q** RAS (25 pins)
- R** CF Card Interface Cover
- S** Power Connector

Interface Specification

Communication Connections

 DANGER

EXPLOSION HAZARD

- Always confirm the UL 1604, ANSI/ISA 12.12.01 or CSA C22.2 N° 213 hazardous location rating of your device before installing or using it in a hazardous location.
- To apply or remove the supply power from a Smart 15" device installed in a Class I, Division 2 hazardous location, you must either:
 - Use a switch located outside the hazardous environment, or;
 - Use a switch certified for Class I, Division 1 operation inside the hazardous area.
- Do not connect or disconnect any cables or wires while the circuit is live unless the area is known to be free of ignitable concentrations of vapors, gases, and other flammable or combustible materials. This applies to all connections including power, ground, serial, parallel, and network connections.
- Never use unshielded / ungrounded cables in hazardous locations.
- Use only non-incendiary USB devices (*see page 79*).
- When enclosed, keep enclosure doors and openings closed at all times to avoid the accumulation of foreign matter inside the workstation.

Failure to follow these instructions will result in death or serious injury.

 WARNING

EQUIPMENT DISCONNECTION OR UNINTENDED EQUIPMENT OPERATION

- Ensure that power, communication, and accessory connections do not place excessive stress on the ports. Consider the vibration environment when making this determination.
- Securely attach power, communication, and external accessory cables to the panel or cabinet.
- Use only commercially available USB cables.

Failure to follow these instructions can result in death, serious injury, or equipment damage.

Serial Interfaces

COM 1 and COM 2: These interfaces are used to connect an RS-232C (serial) cable. A D-SUB 9 pin plug connector is used.

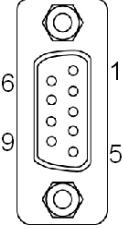
Pin Arrangement	Pin No.	RS-232C		
		Signal Name	Direction	Meaning
	1	CD	Input	Carrier Detect
	2	RXD	Input	Receive Data
	3	TXD	Output	Send Data
	4	DTR	Output	Data Terminal Ready
	5	SG	–	Signal Ground
	6	DSR	Input	Data Set Ready
	7	RTS	Output	Request to Send
	8	CTS	Input	Send Possible
	9	RI	Input	Called status display (+ 5Vdc)
	Shell	FG	–	Frame Ground (Common with SG)

RAS Interface

The types of sockets for D-SUB 25 pins are listed in the table below:

Pin arrangement	Pin No.	Signal Name	Meaning
	1	GND	Ground
	2	+5Vdc	Output current: 100 mA or less (with a total of 2 pin and 15 pin) Output voltage: 5Vdc +/- 5%
	3	+12Vdc	Output current: 100 mA or less Output voltage: 12Vdc +/- 5%
	4	NC	-
	5	RST(+)	Reset in(+)
	6	DIN0(+)	Data in 0(+)
	7	DOUT2(-) UPS Shutdown(-)	Data out 2(-) (UPS Shutdown(-))
	8	DOUT2(+) UPS Shutdown(+)	Data out 2(+) (UPS Shutdown(+))
	9	DOUT0(-)	Data out 0(-)
	10	DOUT0(+)	Data out 0(+)
	11	RST(-)	Reset in(-)
	12	DIN0(-)	Data in 0(-)
	13	DIN1(+)	Data in 1(+)
	14	GND	Ground
	15	+5 Vdc	Output current: 100 mA or less (with a total of 2 pin and 15 pin) Output voltage: 5Vdc +/- 5%
	16	DIN2(+)	Data in 2(+)
	17	DIN2(-)	Data in 2(-)
	18	DIN3(+)	Data in 3(+)
	19	DOUT1(-)	Data out 1(-)
	20	DOUT1(+)	Data out 1(+)
	21	DOUT3(-)	Data out 3(-)
	22	DOUT3(+)	Data out 3(+)
	23	DIN3(-)	Data in 3(-)
	24	DIN1(-)	Data in 1(-)
	25	NC	-

Recommended connector: XM2A-0901 Manufactured by Omron Co.

Recommended cover: XM2S-0913 Manufactured by Omron Co.

Jack Screw: XM2Z-0073 Manufactured by Omron Co.

Input (DIN 0, 1, 2, 3)

INPUT VOLTAGE RANGE	12...24 Vdc
INPUT CURRENT	Below 10 mA
INNER RESISTOR	3.6 K Ω
INSULATION VOLTAGE	Below 500 Vac
INSULATION	Photocoupler

Output (DOUT 0,1, 2, 3)

OUTPUT VOLTAGE RANGE	24 Vdc
OUTPUT CURRENT	Below 120 mA
INSULATION VOLTAGE	Below 500 Vac
INSULATION	Photocoupler

Characteristics

3

Subject of this Chapter

This chapter lists the product characteristics.

What's in this Chapter?

This chapter contains the following topics:

Topic	Page
Characteristics of the Smart 15"	44
Flash Disk Characteristics	47
Environmental Characteristics	48

Characteristics of the Smart 15"

Introduction

The characteristics of the Smart 15" models are given below:

Product Characteristics

Element	Characteristics
Processor	ULV Celeron M 1 GHz, secondary memory cache 512 KB
RAM	1 GB RAM
Flash Disk	Capacity greater or equal to 15 GB (Refer to Flash Disk Characteristics (<i>see page 47</i>))
Video processor	Integrated Intel 855 GME video, sharing main memory. 8/16/32 bit color resolution at 1024x768.
Ethernet TCP/IP link	LAN1: 10/100Base-T LAN2: 10/100/1000Base-T
USB ports	4 x USB 2.0 (bottom side), 1 x USB 2.0 (front face)
Keyboard	PS/2 interface (mini Din 6 pin, female)
RAS Interface	D-SUB 25 Pin x1 (male)
COM 1 and COM 2 serial ports	RS232C
Memory flash card slot	Compact Flash type
PCMCIA slot	2 ports on side (Type II)
Audio port	Speaker out (mini-jack interface)
Dimensions (WxHxD)	395 x 294 x 60 mm (15.55 x 11.57 x 2.36 in.)
Weight	6.0 kg (13.23 lb)

NOTE: If a USB high speed device such as a webcam or a memory key isn't recognized by the Smart, or doesn't operate as expected, plug it into USB port #2 and leave USB port #1 empty.

Display Characteristics

Element	Characteristics
Graphics	XGA TFT active matrix (1024x768 pixels)
Number of colors	262144
Brightness	250 cd/m ²
Brightness Control	4 levels of adjustment

Element	Characteristics
View angle	Vertical 100°, horizontal 160° Typ.
Touch sensitive screen	Analog resistive film, resolution 1024x1024
Backlight	CFL - Life span > 50,000 h at 25° C (77° F)

Power Supply

For the Smart 15" DC (References HMIPSC7D**3, HMIGTW7353 and HMIPSF7D**3):

Element	Characteristics
Supply voltage	24 Vdc (19.2 Vdc to 28.8 Vdc)
Consumption	90 W (max.)
Short dips	5 ms (max.)
PCI extension slot capability	Board size 240 x 106.68 mm (9.45 x 4.2 in.) <ul style="list-style-type: none"> ● 5 Vdc, 1.5 A ● 12 Vdc, 0.5 A ● 12 Vdc, 0.1 A ● 3.3 Vdc, 0.5 A

For the Smart 15" AC (References HMIPSC7A**3 and HMIPSF7A**3):

Element	Characteristics
Supply voltage	100...240 Vac (Range 85 ... 265 Vac)
Consumption	70 VA (max.)
Short dips	10 ms (20 ms max.)
PCI extension slot capability	Board size 240 x 106.68 mm (9.45 x 4.2 in.) <ul style="list-style-type: none"> ● 5 Vdc, 1.5 A ● 12 Vdc, 0.5 A ● 12 Vdc, 0.1 A ● 3.3 Vdc, 0.5 A

Operating Systems

The products are delivered with a preinstalled operating system according to the reference ordered: Microsoft Windows® XPe.

Reference	Characteristics
HMIPSC7DE03	Smart with 15" XGA Display, Touch screen, Celeron M 1 GHz, 2 GB Compact Flash with Windows® XPe preinstalled, DC supply power. (Client Edition)
HMIPSC7AE03	Smart with 15" XGA Display, Touch screen, Celeron M 1 GHz, 2 GB Compact Flash with Windows® XPe preinstalled, AC supply power. (Client Edition)
HMIGTW7353	Smart with 15" XGA Display, Touch screen, Celeron M 1 GHz, 2 GB Compact Flash with Windows® XPe and Vijeo Designer Run Time pre-installed, DC supply power. (Graphical Terminal)
HMIPSF7DP03	Smart+ with 15" XGA Display, Touch screen, Celeron M 1 GHz, 15 GB Flash disk with Windows® XPpro preinstalled, DC supply power.
HMIPSF7AP*3	Smart+ with 15" XGA Display, Touch screen, Celeron M 1 GHz, 15 GB Flash disk with Windows® XPpro preinstalled, AC supply power

Flash Disk Characteristics

Introduction

The Smart 15" products offer Flash Disk hard drives (also known as Solid-State Drives or SSDs). Flash Disk hard drives are available only on HMIPSF7*** models. All Flash Disk references are ATA-3 compliant and have no moving parts.

Characteristics

A Flash Disk (SSD) is a storage device based on semiconductors rather than rotating magnetic platters. The use of semiconductors allows a Flash Disk to perform normal storage functions while providing enhanced levels of performance and reliability. Flash Disk drives use the same industry-standard dimensions and data interfaces as conventional hard disk drives and may be used interchangeably in Smart 15" systems.

The references with Flash Disks share the same characteristics as other Smart 15" devices except as noted in the following table:

Characteristics	Values	Standards
Capacity	15 GB or higher	—
MTBF	> 4,000,000 Hours at 25° C (77° F)	—
Data Reliability	< 1 unrecoverable error in 10 ¹⁴ bits read	—
Endurance	> 2,000,000 write/erase cycles	—
Shock resistance (in operation)	15 g over 11 ms, 3 shocks per axis	IEC 68-2-27 Ea test EN/IEC 61131-2 compliant
Shock component value	1000 g, half-sine, 0.5 ms duration, 50 g peak	MIL-STD-810F, Method 516.5, Procedure I
Vibration resistance (in operation)	3.5 mm amplitude from 3 to 9 Hz 1 g amplitude from 9 to 150 Hz	EN/IEC 61131-2 compliant
Vibration component value	16.3 g RMS	MIL-STD-810F, Method 514.5, Procedure I, Category 24

Environmental Characteristics

Characteristics

The environmental characteristics of the Smart 15" are as follows:

Characteristics	Value	Standards
Degree of Protection	IP 65/NEMA4x/12 for the front panel when installed. IP 20 for the rest of the product.	IEC 60529, NEMA 250, UL50, EN/IEC 61131-2
Pollution Degree	For use in Pollution Degree 2 environment	EN/IEC 61131-2
Surrounding air temperature during operation	0 ... 50 °C (32 ... 122 °F)	EN/IEC 61131-2, UL
Storage temperature	- 20 ... 60 °C (- 4 ... 140 °F)	IEC 60068-2-2 tests Bb and Ab, IEC 60068-2-14 tests Na and EN/IEC 61131-2 compliant
Operating altitude	2000 m (6560 ft) max	EN/IEC 61131-2
Vibration (in operation)	3.5 mm amplitude from 5 to 9 Hz, 1 g amplitude from 9 to 150 Hz	EN/IEC 61231-2
Shock Resistance (in operation)	15 g over 11 ms	IEC 60068-2-27 Ea test and EN/IEC 61131-2 compliant
Surrounding air humidity during operation	10 ... 85% RH (Wet bulb temperature: 29 °C (84.2 °F) max. - no condensation)	-
Storage humidity	10 ... 85% RH (Wet bulb temperature: 29 °C (84.2 °F) max. - no condensation)	EN 61231-2
Immunity to interference	High frequency interference	EN/IEC 61131-2, IEC 61000-4-3/6 level 3
	Electromagnetic waves	Class A/EN 55022/55011
Additional Standards	Information Technology Equipment	IEC 60950
	Information Control Equipment	UL 508, CSA 22.2 No142

Dimensions/Assembly



Subject of this Chapter

This chapter concerns the dimensions and the panel mounting of products.

What's in this Chapter?

This chapter contains the following topics:

Topic	Page
Dimensions	50
Panel Mounting	53
Preparing to Install the 15" Smart	55

Dimensions

Dimensions of the Smart Unit

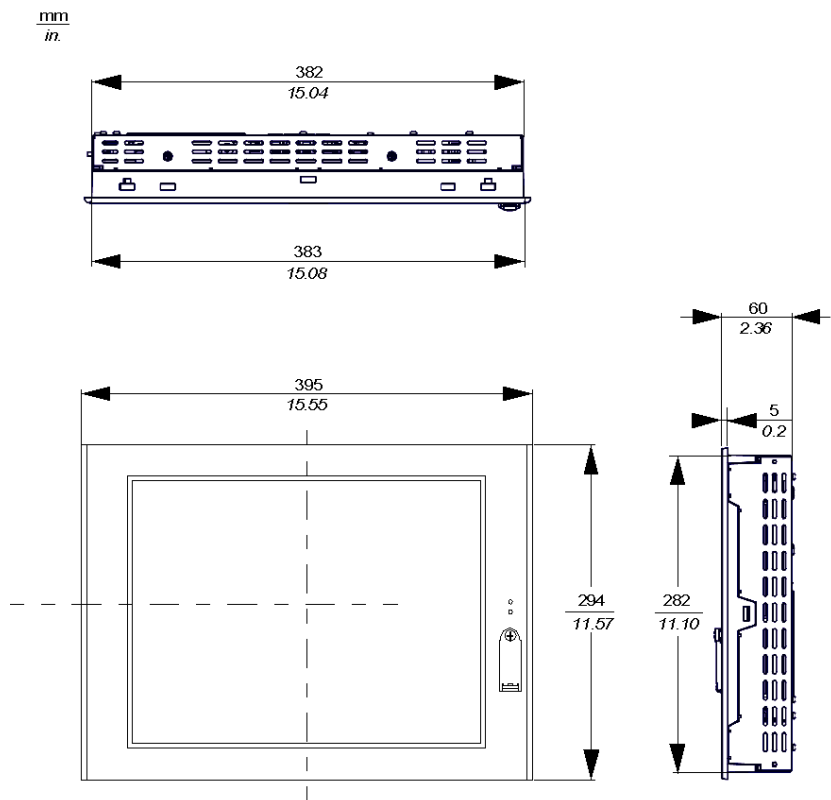

InstallationFastener Dimensions

The products are designed to be mounted in a cabinet with the attachments described below:

$\frac{\text{mm}}{\text{in.}}$

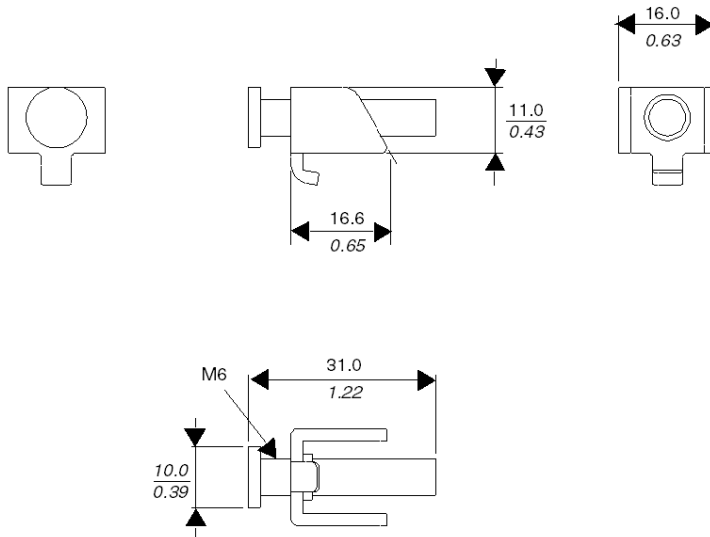

Dimensions with Installation Fasteners

$\frac{\text{mm}}{\text{in.}}$

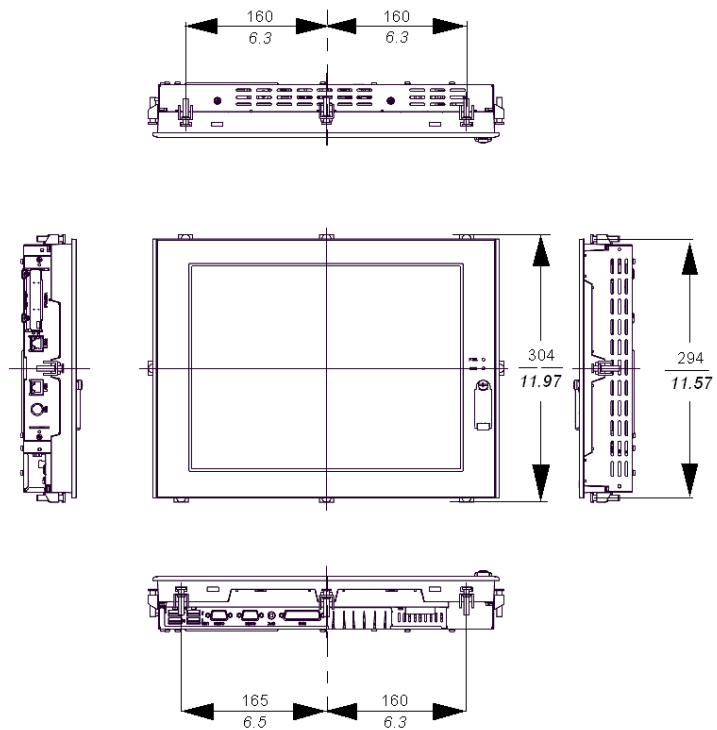

Panel Mounting

Installation Location

WARNING

UNINTENDED EQUIPMENT OPERATION

Overheating can cause incorrect software behavior, therefore:

- Avoid placing the Smart unit next to other devices that might cause overheating.
- Keep the Smart unit away from arc-generating devices such as magnetic switches and non-fused breakers.
- Avoid using the Smart unit in environments where corrosive gases are present.
- Install the Smart in a location providing a minimum clearance of 50 mm (2 in.) or more from all adjacent structures and equipment.
- Install the Smart with sufficient clearance to provide for cable routing and cable connector dimensions.

Failure to follow these instructions can result in death, serious injury, or equipment damage.

Creating a Panel Cut-out for Cabinet Installation

For cabinet installation, it is necessary for the correct sized opening to be cut in the installation panel. The installation gasket and installation fasteners are required when installing the Smart.

Dimensions

The dimensions of the opening required to install the Smart unit are shown below:

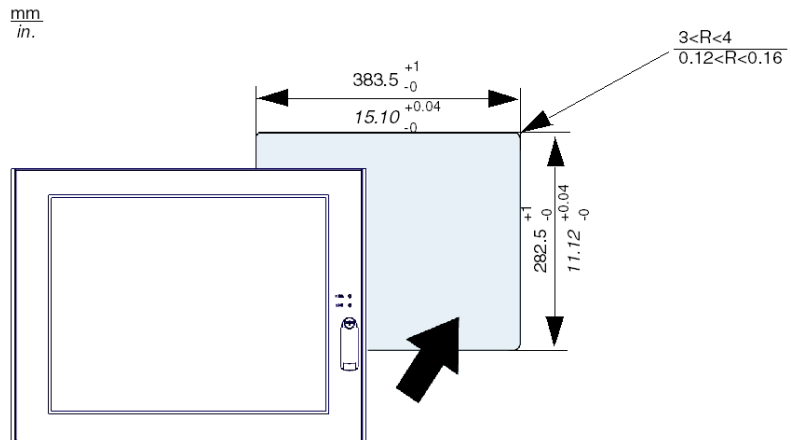
**NOTE:**

- Ensure the thickness of the installation panel is from 1.6 to 10 mm (0.06 to 0.39 in.)
- All panel surfaces used should be strengthened. Due consideration should be given to the product's weight, especially if high levels of vibration are expected and the product's installation surface can move. Metal reinforcing strips can be attached to the inside of the panel near the panel cut-out, to increase the strength of the panel.
- Ensure all installation tolerances are maintained.
- The Smart 15" is designed for use in a NEMA Type 4X or 12 enclosure.

Preparing to Install the 15" Smart

Vibration and Shocks

Extra care should be taken with respect to the specification concerning vibration levels when installing or moving the Smart. If the Smart is moved, for example, while it is installed in a rack equipped with caster wheels, the unit can receive excessive shock and vibration.

CAUTION

EXCESSIVE VIBRATION

- Plan your installation activities so that device shock and vibration tolerances are not exceeded.
- Ensure that the panel opening and thickness are within the specified tolerances.
- Before mounting the Smart unit into a cabinet or panel, ensure that the installation gasket is attached to the unit. The installation gasket provides additional protection from vibration.
- The recommended torque for mounting the Smart 15" device is 0.5 N•m (4.5 lb-in).

Failure to follow these instructions can result in injury or equipment damage.

Installation Gasket

Use of the installation gasket may help extend the operating life of your Smart. The gasket is required to meet the protection ratings (IP65, IP20, NEMA4) of the unit and provides additional protection from vibration. Even if moisture protection is not required, install the gasket delivered with your Magelis product.

CAUTION

LOSS OF SEAL

- Inspect the installation gasket prior to installation or reinstallation, and periodically as required by your operating environment.
- Replace the gasket if visible scratches, tears, dirt, or excessive wear are noted during inspection.
- Do not stretch the gasket unnecessarily or allow the gasket to contact the corners or edges of the frame.
- Ensure that the gasket is fully seated in the installation groove.
- Install the Smart into a panel that is flat and free of scratches or dents.
- Tighten the installation fasteners using a torque of 0.5 N•m (4.5 lb-in).

Failure to follow these instructions can result in injury or equipment damage.

The corresponding gasket is provided in the maintenance kit ref:
MPC YK 50 MNT KIT.

Installation Fasteners

CAUTION

OVERTORQUE AND LOOSE HARDWARE

- Do not exert more than 0.6 N•m (5.3 lb-in) of torque when tightening the installation fastener, enclosure, accessory, or terminal block screws. Tightening the screws with excessive force can damage the plastic casing of the Smart15"
- When installing or removing screws, ensure that they do not fall inside the Smart 15" unit's chassis.



Failure to follow these instructions can result in injury or equipment damage.

NOTE: The screw installation fasteners are required for NEMA4 protection.

Installing the Smart Unit

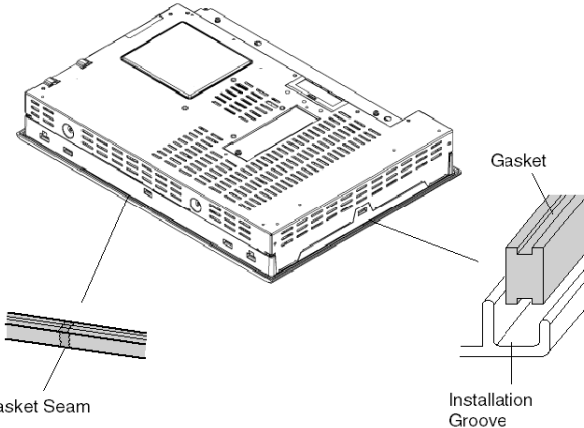
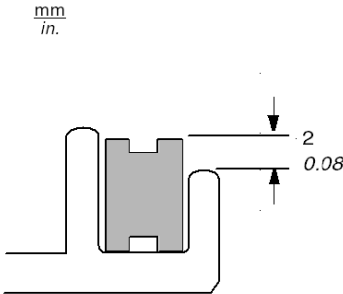
Follow the steps given below when installing the Smart.

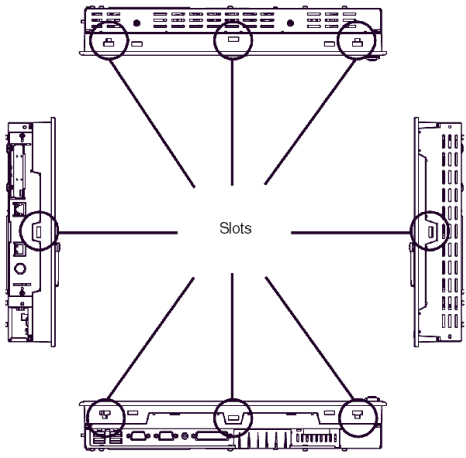
Step	Action
1	<p>Place the unit face down on a dry, soft surface and attach the gasket to the rear side, in the installation groove (see picture below):</p> 
2	<p>Check that the gasket is correctly attached to the unit. The upper surface of the gasket should protrude evenly approximately 2 mm (0.08 in.) out of the groove.</p> <p>Note: When installing the Smart unit's installation gasket, avoid contact with the sharp edges of the Smart's frame, and press the gasket completely into its groove.</p>  <p style="margin-left: 40px;"> $\frac{\text{mm}}{\text{in.}}$ </p>

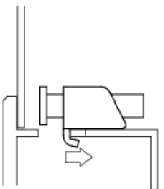
Step	Action
3	<p>Insert each installation fastener securely into the slot's recess at the top and bottom of the unit:</p> 
4	<p>Attach and Secure the Rear Installation Attachments:</p>  <p>Note:</p> <ul style="list-style-type: none"> ● Excessive torque may damage the Smart unit. ● To ensure a high degree of moisture resistance, the torque should be 0.5 N•m (4.5 lb-in). ● Insert each of the fasteners as shown below. Be sure to pull the fasteners back until it is flush with the rear of the attachment hole.
5	<p>Insert each of the fasteners. Pull the fastener back until it is flush with the rear of the attachment hole.</p> <p>Note: The corresponding installation attachments can be purchased as spare parts with the maintenance kit ref.: MPC YK 50 MNT KIT.</p> 

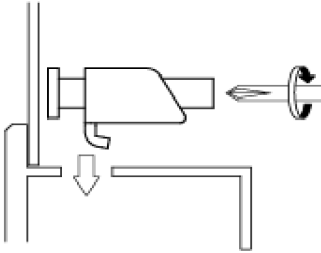
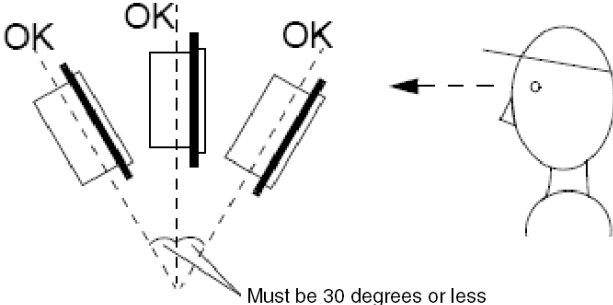
Step	Action
6	<p data-bbox="445 203 1211 251">Use a screw driver to tighten to 0.5 N•m (4.5 lb-in) each of the fastener screws and secure the Smart in place:</p> 
7	<p data-bbox="445 609 1167 690">Smart Viewing Angle (See Display Characteristics (<i>see page 44</i>)). Ensure that the panel's viewing angle is tilted no more than 30 degrees from parallel to the operator (i.e. operator is directly in front).</p> 

Implementation



Subject of this Part

This part describes the implementation of the product.

What's in this Part?

This part contains the following chapters:

Chapter	Chapter Name	Page
5	Getting Started	63
6	Main Power Connection	67
7	Configuration of the BIOS	81
8	Hardware Modifications	85

Getting Started

5

First Power-up

License Agreement

NOTE: Limitations on your usage of the Windows XPe or Windows XPpro Operating System are noted in Microsoft's End User License Agreement (EULA). This EULA is included on the CD-ROM. Please read this document before first power-up.



On first power-up of your HMIPS****, it is necessary to customize and set the parameters for your system. Refer to the Magelis Installation Guide.



Install, customize and parameterize the Schneider Electric applications (Unity pro, PL7 Junior or PL7 Pro, Vijeo Designer, Vijeo Designer Lite, OFS, MMI 17, XBTL 1000, PL7-07).

Some Useful Tools

A selection of program icons are displayed on the task bar which can be used to launch some useful programs:



Icon	Usage
	This is the virtual keyboard. Once you click on it, a graphical keyboard is displayed. It is useful when you do not want to connect, or cannot connect a keyboard to the unit.
	This is the virtual mouse button selector. It allows the user to associate the next "click" to a "right click". For instance, this tool permits the use of context sensitive menus.

Icon	Usage
	Configuration Panel / Brightness: this link allows the user to change the brightness of the screen (useful for dark areas).
	These icons indicate the status of the Enhanced Write Filter (EWF) Manager. They are located in the system tray on the Windows taskbar. Only available for Smart with Windows® XPe pre-installed

EWF Manager Enhanced Write Filter

The Magelis Smart HMIPSC7**** and HMIGTW7353 operating system, Windows® XPe, is installed on a memory cartridge. This cartridge is a re-writable "Compact Flash" card and it allows approximately 100,000 write operations before it should be replaced.

The Enhanced Write Filter (EWF) Manager minimizes the number of write operations to help extend the life of the CF Card. It loads temporary data (for example, system updates and software operations) into RAM, and does not at any point write this information to the CF Card.

Therefore, if the EWF is enabled, a restart of the Smart 15" will cause any changes the user made to the system to be overwritten. The following types of modifications may be overwritten if the EWF Manager is active and the system is restarted:

- Newly installed applications
- Newly installed peripherals
- Newly created or modified user accounts
- Network configuration changes (e.g., IP address, default gateway, etc.)
- Operating System customizations (background pictures, etc.)

CAUTION

DATA AND CONFIGURATION LOSS

- Disable the EWF Manager before making any permanent changes to the hardware, software, or Operating System of the Smart 15" device. Confirm that the EWF icon in the Windows system tray has a red "X".
- Re-enable the EWF Manager after making permanent changes and confirm that the EWF icon in the Windows system tray does not have a red "X". This can help extend the operating life of the CF Card.
- Back up all CF Card data regularly to another storage media.

Failure to follow these instructions can result in equipment damage.

Enabling/Disabling of EWF Manager

The status of the EWF Manager may be changed by running the `ChangeEWFstate.exe` program located in the `C:\Program files\Schneider Electric\EWF` directory. After running this program, a system restart is required for the change to take effect. Administrator privileges are required to enable and disable the EWF Manager.

Main Power Connection



6

Subject of this Chapter

This chapter describes the connection of the Smart 15" to the main power supply.

What's in this Chapter?

This chapter contains the following topics:

Topic	Page
Grounding	68
Installing the Power Switch Cover	71
Connecting the DC Power Cord	73
Connecting the AC Power Cord	77
Control Drawing of the USB outlet on the Magelis iPC	79

Grounding

Overview

The grounding resistance between the Smart's Frame Ground (FG) and Ground must be 100 Ω or less. When using a long grounding wire, check the resistance and if required replace a thin wire with a thicker wire and place it in a duct. In addition, please refer to the table below for maximum line lengths for the thickness of wire.

Ground Wire Dimensions

Wire Thickness	Maximum Line Length
2 mm ² (14 AWG)	30 m (98 ft.)
	60 m (196 ft.) round trip.
1.5 mm ² (16 AWG)	20 m (65 ft.)
	40 m (131 ft.) round trip.

Precaution

⚠ WARNING

UNINTENDED EQUIPMENT OPERATION

- Use only the authorized grounding configurations shown below.
- Confirm that the grounding resistance is 100 Ω or less.
- Test the quality of your ground connection before applying power to the device.
Excess noise on the ground line can disrupt the Smart's operations.

Failure to follow these instructions can result in death, serious injury, or equipment damage.

Dedicated Ground

Connect the Frame Ground (FG) to a dedicated ground.

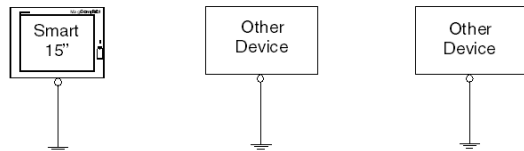

Shared Ground Allowed

If a dedicated ground is not possible, use a shared ground, as shown below.

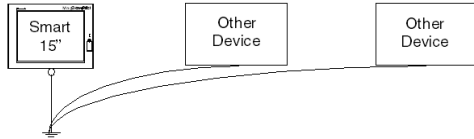

Shared Ground not Allowed

Do not connect the Smart 15'' unit to ground through other devices using the SG terminals.

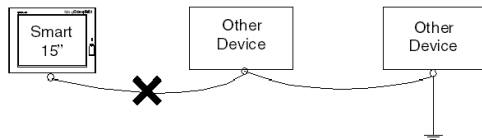

Shared Ground - Avoid Ground Loop

When connecting an external device to a Smart with the Shield Ground (SG), ensure that no ground loop is created. The Smart's FG and SG are connected internally.

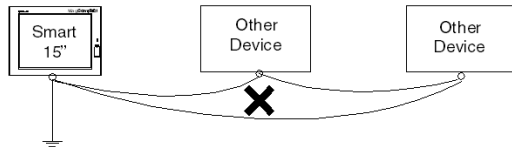

Grounding Procedure

When grounding, follow the procedures given below:

Step	Action
1	Check that the grounding resistance is 100 Ω or less.
2	When connecting the SG line to another device, ensure that the design of the system/connection does not produce a ground loop. Note: the SG and FG terminals are connected internally in the Smart 15''.
3	Whenever possible, use 2 mm ² (14 AWG) wire to make the ground connection. If this isn't possible, ensure that the grounding wire gauge and length conform to the table in Ground Wire Dimensions (<i>see page 68</i>). Create the connection point as close to the iCP as possible and make the wire as short as possible.

Grounding I/O Signal Lines

DANGER

EXPLOSION HAZARD

- Always confirm the UL 1604, ANSI/ISA 12.12.01 or CSA C22.2 N° 213, hazardous location rating of your device before installing or using it in a hazardous location.
- To apply or remove the supply power from a Smart 15" device installed in a Class I, Division 2 hazardous location, you must either:
 - Use a switch located outside the hazardous environment, or;
 - Use a switch certified for Class I, Division 1 operation inside the hazardous area.
- Do not connect or disconnect any cables or wires while the circuit is live unless the area is known to be free of ignitable concentrations of vapors, gases, and other flammable or combustible materials. This applies to all connections including power, ground, serial, parallel, and network connections.
- Never use unshielded / ungrounded cables in hazardous locations.
- Use only non-incendiary USB devices (*see page 79*).
- When enclosed, keep enclosure doors and openings closed at all times to avoid the accumulation of foreign matter inside the workstation.

Failure to follow these instructions will result in death or serious injury.

WARNING

UNINTENDED EQUIPMENT OPERATION

- Do not wire I/O lines in proximity to power cables, radio devices, or other equipment that may cause electromagnetic interference.
- If wiring of I/O lines near power lines or radio equipment is unavoidable, use shielded cables and ground one end of the shield to the Smart's Frame Ground (FG).

Electromagnetic radiation may interfere with the Smart's control communications.

Failure to follow these instructions can result in death, serious injury, or equipment damage.

Installing the Power Switch Cover

Introduction

In hazardous locations, AC powered devices must be equipped with a power switch compliant with Class I, Division 2 requirements (see *Hazardous Location Installations - For USA and Canada, page 23*).

To make the power switching compliant with Class I, Division 1 requirements, you must:

- install a power switch cover on your Smart unit power switch
- use only a remote main power switch located outside the Smart unit location to switch power on or off.

DANGER

HAZARD OF ELECTRIC SHOCK, EXPLOSION OR ARC FLASH

- Remove all power from the device before removing any covers or elements of the system and prior to installing or removing any accessories, hardware, or cables.
- Always use a properly rated voltage sensing device to confirm power is off.
- Unplug the power cable from both the Smart unit and the power supply.
- Replace and secure all covers or elements of the system before applying power to the unit.
- Use only the specified voltage when operating the Smart 15". The AC unit is designed to use 100 ... 240 Vac input. The DC unit is designed to use 23 ... 25 Vdc. Always check whether your device is AC or DC powered before applying power.

Failure to follow these instructions will result in death or serious injury.

Installing the Power Switch Cover

The procedure below describes how to install a power switch cover:

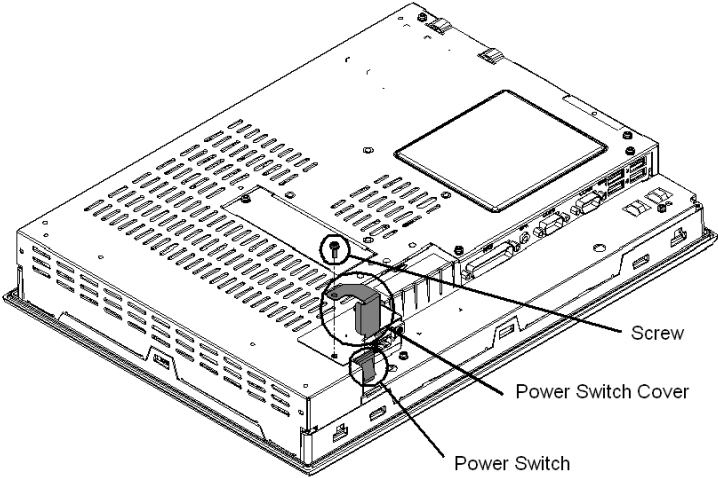
Step	Action
1	Shut down Windows® in an orderly fashion and remove all power from the device.
2	Remove the Smart unit from its mounting and place it on a clean level surface with the front panel facing downwards.
3	Switch ON the power switch.
4	Attach the power switch cover with the screw. Use a torque of 0.5 to 0.6 N•m (4.5 to 5.3 lb-in):
	
5	First ensure that the power cord is disconnected from the main power supply, then connect the power cord to the Smart unit (see <i>Connecting the AC Power Cord</i> , page 77).

Remote Main Power Switch

NOTE: After installing the Smart unit power switch cover, this power switch should not be used anymore.

To power on or off, you must either:

- use the main power switch located outside the Smart unit location, or:
- connect or disconnect the AC power cord connector, located outside the Smart unit location, from the main power supply connector.

Connecting the DC Power Cord

Precaution

When connecting the Smart unit's power cable to the power connector on the unit, first ensure that the power cord is disconnected from the main DC power supply.

DANGER

HAZARD OF ELECTRIC SHOCK, EXPLOSION OR ARC FLASH

- Remove all power from the device before removing any covers or elements of the system, and prior to installing or removing any accessories, hardware, or cables.
- Always use a properly rated voltage sensing device to confirm power is off.
- Unplug the power cable from both the Smart unit and the power supply.
- Replace and secure all covers or elements of the system before applying power to the unit.
- Use only the specified voltage when operating the Smart 15". The AC unit is designed to use 100...240 Vac input. The DC unit is designed to use 23 ... 25 Vdc. Always check whether your device is AC or DC powered before applying power.

Failure to follow these instructions will result in death or serious injury.

WARNING

EQUIPMENT DISCONNECTION OR UNINTENDED EQUIPMENT OPERATION

- Ensure that power, communication, and accessory connections do not place excessive stress on the ports. Consider the vibration environment when making this determination.
- Securely attach power, communication, and external accessory cables to the panel or cabinet.
- Use only commercially available USB cables.

Failure to follow these instructions can result in death, serious injury, or equipment damage.

Wiring and Connecting the Terminal Block (DC Smart Version)

When wiring and connecting the Smart power cables, be sure to follow the procedures given below:

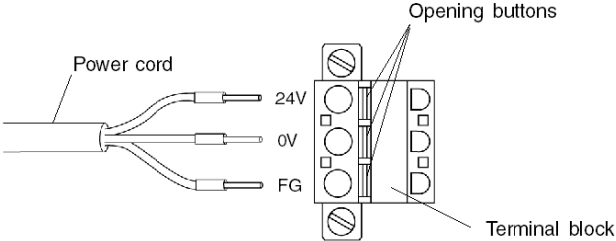
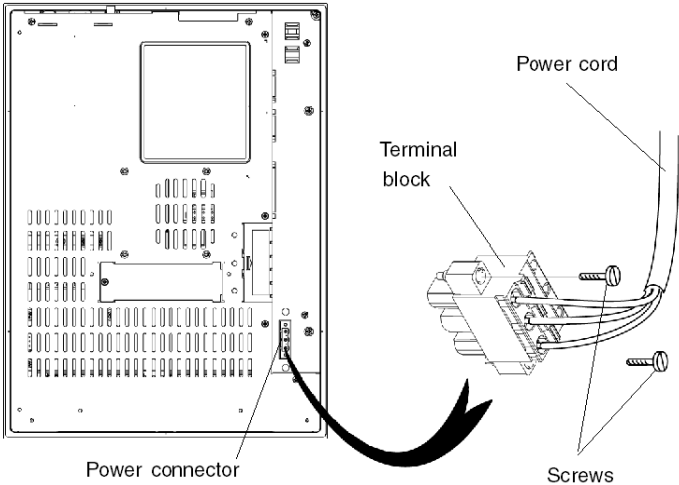
Step	Action
1	Remove all power from the Smart 15" and confirm that the DC power supply has been disconnected from its power source.
2	<p>Connect the power cord (see page 30) to the terminal block as shown below.</p>  <p>Use wire with cross-section 0.75 mm² to 2.5 mm² (AWG18 to AWG12)</p>
3	<p>Place the terminal block in the power connector and tighten the screws. The recommended torque to tighten these screws is 0.5 N•m (4.5 lb-in):</p> 

NOTE: The 24 Vdc power supply inside the DC-powered Smart unit is protected by an 8A fuse. This fuse is located inside the power supply and cannot be accessed or replaced by the user.

Possible Connections

Connection to a Floating (Ungrounded) DC Power System:

Some specific applications require the use of a floating (ungrounded) power system. The characteristics of such a system, as it might apply when a DC-powered Smart 15" is installed, are as follows:

- The 0 Vdc power line and Frame Ground (FG) are connected internally.
- The 24 Vdc power line is isolated from the FG and from the outputs. The dielectric strengths for these are:
 - Primary/Secondary: 1000 Vac
 - Primary/Ground: 1000 Vac

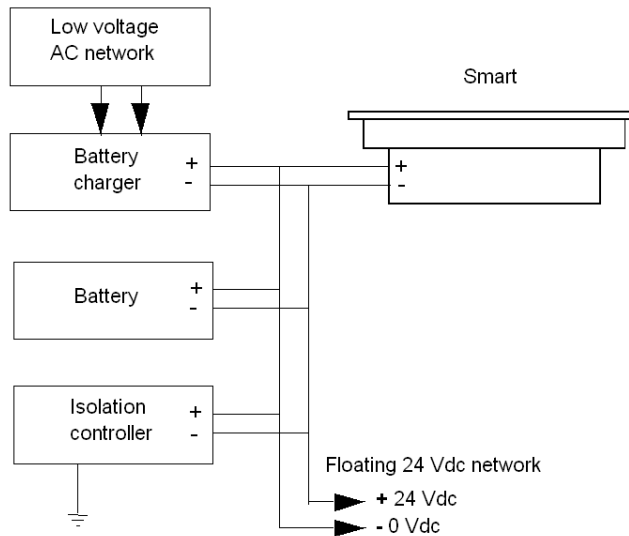

Connection to a Ground-Referenced DC Power System:

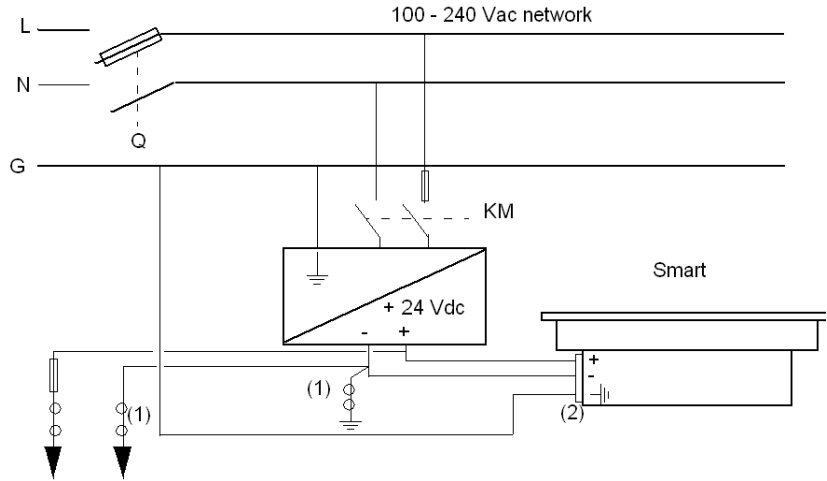

Q : Mains Power Contactor

KM : Line contactor

(1) : Residual Current Detector for detecting grounding faults

(2) : Terminal block

NOTE: Schneider suggests the use of the TSX SUP 1101 DC Power Supply to provide the Smart unit's 24 Vdc power.

Connecting the AC Power Cord

Precaution

DANGER

HAZARD OF ELECTRIC SHOCK, EXPLOSION OR ARC FLASH

- Remove all power from the device before removing any covers or elements of the system and prior to installing or removing any accessories, hardware, or cables.
- Always use a properly rated voltage sensing device to confirm power is off.
- Unplug the power cable from both the Smart unit and the power supply.
- Replace and secure all covers or elements of the system before applying power to the unit.
- Use only the specified voltage when operating the Smart 15". The AC unit is designed to use 100...240 Vac input. The DC unit is designed to use 23 ... 25 Vdc. Always check whether your device is AC or DC powered before applying power.

Failure to follow these instructions will result in death or serious injury.

WARNING

EQUIPMENT DISCONNECTION OR UNINTENDED EQUIPMENT OPERATION

- Ensure that power, communication, and accessory connections do not place excessive stress on the ports. Consider the vibration environment when making this determination.
- Securely attach power, communication, and external accessory cables to the panel or cabinet.
- Use only commercially available USB cables.

Failure to follow these instructions can result in death, serious injury, or equipment damage.

Power Cord Connection (AC Smart Version)

The table below describes how to connect the power cord to the Smart unit:

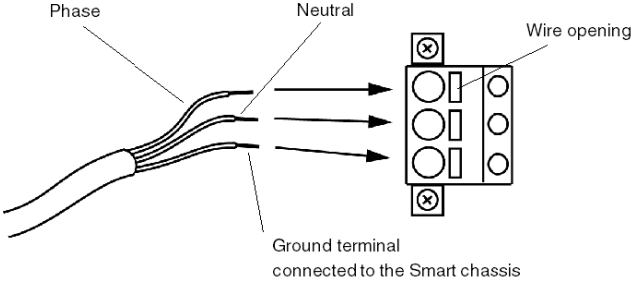
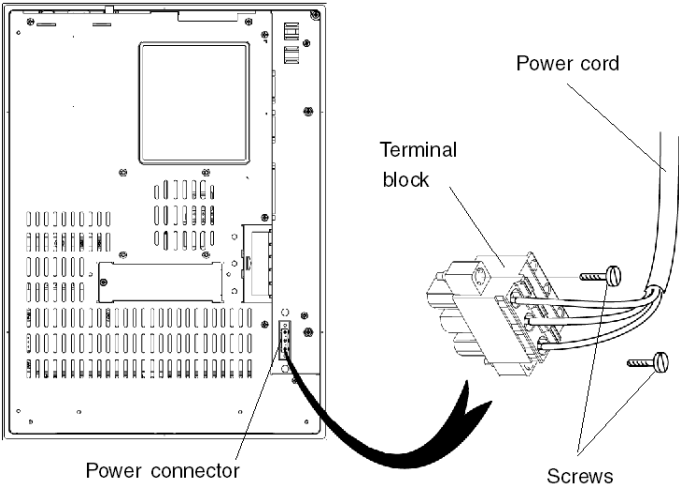
Step	Action
1	<p>Connect the power cord to the terminal block as shown below:</p> 
2	<p>Place and screw the terminal block on the Smart unit's power connector. Tighten the screws using a torque of 0.5 to 0.6 N·m (4.5 to 5.3 lb-in)</p> 

Control Drawing of the USB outlet on the Magelis iPC

Introduction

The information below concerns the use of the USB outlet located on the front panels of the Magelis iPC used in Class I, Division 2 Groups A, B, C, and D hazardous locations.

DANGER

EXPLOSION HAZARD

- Always confirm the UL 1604, ANSI/ISA 12.12.01 or CSA C22.2 N° 213 hazardous location rating of your device before installing or using it in a hazardous location.
- To apply or remove the supply power from a Smart 15" device installed in a Class I, Division 2 hazardous location, you must either:
 - Use a switch located outside the hazardous environment, or;
 - Use a switch certified for Class I, Division 1 operation inside the hazardous area.
- Do not connect or disconnect any cables or wires while the circuit is live unless the area is known to be free of ignitable concentrations of vapors, gases, and other flammable or combustible materials. This applies to all connections including power, ground, serial, parallel, and network connections.
- Never use unshielded / ungrounded cables in hazardous locations.
- Use only non-incendiary USB devices.
- When enclosed, keep enclosure doors and openings closed at all times to avoid the accumulation of foreign matter inside the workstation.

Failure to follow these instructions will result in death or serious injury.

Description

Non-incendiary equipment (keyboards, mouse) are permitted for use on the Smart 15” unit’s Front USB port. In addition to being non-incendiary, any equipment connected to the Front USB port must satisfy the following criteria (information taken from Schneider Electric document S1A2983400):

HMIPSC7****, HMIGTW7353
and HMIPSF7****

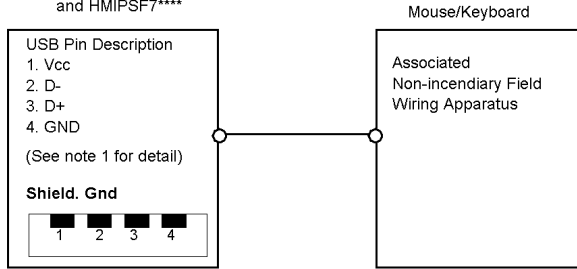

Notes:

1. Non-incendiary Circuit Parameters:

Front USB Port:	
Open-circuit voltage	Voc = 5.0 V
Short-circuit current	Isc = 1.25 A
Associated capacitance	Ca = 10 µF
Associated inductance	La = 16 µH

2. Associated Non-incendiary Field Wiring Apparatus shall satisfy the following:

Associated Non-incendiary Field Wiring Apparatus (Mouse, Keyboard)	-	Magelis iPC
Voc	≤	Vmax
Isc	≤	Imax
Ca	≥	Ci + C cable
La	≥	Li + L cable

3. If the electrical parameters of the cable are unknown, the following values may be used: Capacitance = 60pF/ft and Inductive = 0.20 µH/ft.

4. Non-incendiary Field Wiring must be installed in accordance with article 501.4(B)(3) of the National Electrical Code ANSI/NFPA 70.

5. Associated Non-incendiary Field wiring Apparatus shall not contain or be connected to another source of power.

Configuration of the BIOS

7

Accessing the BIOS

Overview

NOTE: Normally, factory (defaults) settings should be used.

Connect a USB or PS/2 keyboard to the Smart unit.

Switch on the Smart unit power and when prompted to do so, press the F2 key to enter the BIOS.

Main Menu

Selecting the `Main` menu item displays the following screen:

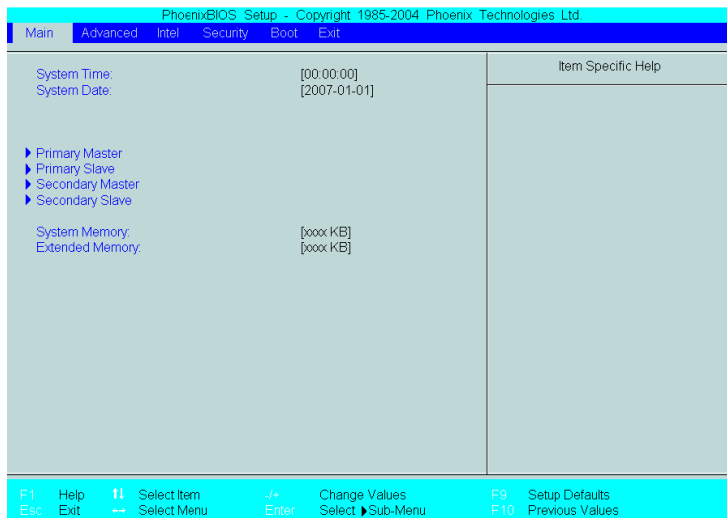

NOTE: When you have finished entering the parameters, press the Esc key to reach the `Exit` menu. Here you will be prompted either to exit saving the changes, or to exit without saving the changes as described below.

System Time

Time (hh:mm:ss)

This field shows the present Smart unit time from the internal clock. The hh/mm/ss (00:00:00) format is factory set prior to shipping.

Hours: 00 to 23

Minutes: 00 to 59

Seconds: 00 to 59

The correct time can be set by using the [+] and [-] keys.

System Date

Date (yy:mm:dd)

This field shows the Smart unit's internal calendar. The correct date can be set by using the [+] and [-] keys.

Year: 1999 to 2099

Month: Jan/Feb/Mar/Apr/May/June/Jul/Aug/Sep/Oct/Nov/Dec

Day: 1 to 31

Primary Master

Displays the name of the devices connected to the primary bus of the Smart. Pressing the Enter key will call up the `Parameter Settings` menu.

Primary Slave

Displays the name of the devices connected to the secondary bus of the Smart. Pressing the Enter key will call up the `Parameter Settings` menu.

System Memory

Displays the capacity of the System Memory.

Extended Memory

Displays the capacity of the Extended Memory.

Password Security

From the Main menu use the Tab key to reach the Security menu. This menu is used for setting Supervisor and User Passwords.

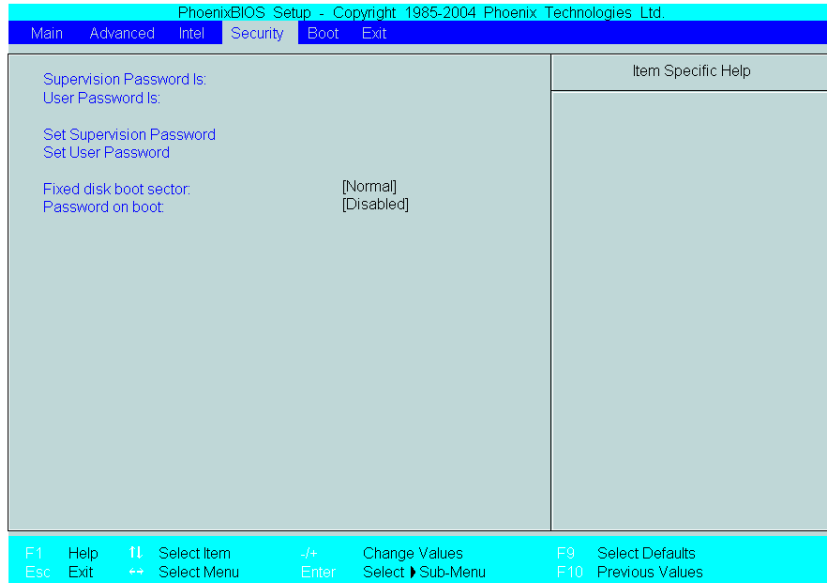

Supervisor Password

This password is used to change system information settings. It is designed to prevent unapproved users from changing these settings. Entering up to 8 characters here will overwrite the current password.

When you wish to have no password, click on the Enter key. Next, the words "PASSWORD DISABLE" will be displayed, providing confirmation that the Password is no longer set.

User Password

This password is used to view system information settings. It is designed to prevent unapproved users from viewing the system information settings. Entering up to 8 characters here will overwrite the current password.

When you wish to have no password, click on the Enter key. Next, the words "PASSWORD DISABLE" will be displayed, providing confirmation that the Password is no longer set.

NOTE:

- Without having defined a Supervisor Password, it is not possible to define a User Password.
- When using `Set Supervisor Password`, you can easily view and change the system settings.
- When using only `Set User Password`, you will be allowed to view the system data only, not change it.

Exit BIOS saving the Modifications

This feature saves the settings entered in the `Setup Utility` and restarts the Smart unit.

Exit BIOS Without Saving Modifications

This feature quits the `Setup Utility` program without saving any settings entered.

Hardware Modifications



Subject of this Chapter

This chapter concerns the hardware modifications for the Magelis Smart 15".

A wide variety of optional units, CF cards manufactured by Schneider Electric and commercial PCMCIA (PC Cards) can be used with this product.

What's in this Chapter?

This chapter contains the following topics:

Topic	Page
Before Modifications	86
Removing the Smart Unit's Cover	89
Smart 15" Internal View	90
USB Front Face	91
PCMCIA Card Installation	93
Compact Flash (CF) Card Installation and Removal	96
USB Cable Clamp Attachment/Removal	99

Before Modifications

Overview

For the detailed installation procedures for the optional units, refer to the OEM (Original Equipment Manufacturer) Installation Guide included with the optional unit.

DANGER

HAZARD OF ELECTRIC SHOCK, EXPLOSION OR ARC FLASH

- Remove all power from the device before removing any covers or elements of the system, and prior to installing or removing any accessories, hardware, or cables.
- Always use a properly rated voltage sensing device to confirm power is off.
- Unplug the power cable from both the Smart unit and the power supply.
- Replace and secure all covers or elements of the system before applying power to the unit.
- Use only the specified voltage when operating the Smart 15". The AC unit is designed to use 100...240 Vac input. The DC unit is designed to use 23 ... 25 Vdc. Always check whether your device is AC or DC powered before applying power.

Failure to follow these instructions will result in death or serious injury.

DANGER

CHEMICAL BURNS TO EYES OR SKIN

- Do not use tools to operate the touch panel or in the vicinity of the display.
- When placing the display face-down, select a clean, level, non-abrasive surface. Place a soft, non-abrasive pad on the surface before lowering the unit upon it.
- If a leak in the LCD panel is discovered, and you come in contact with the liquid crystal material, follow these procedures:
 - In the case of contact with eyes or mouth, flush with running water for 15 minutes minimum.
 - In the case of contact with skin or clothing, wipe off the liquid crystal material and wash with soap and running water for 15 minutes.
 - If liquid crystal is ingested, induce vomiting, rinse mouth, and then drink a large quantity of water.
 - Follow any other hazardous substances safety procedures required by your facility.

Failure to follow these instructions will result in death or serious injury.

 **DANGER****EXPLOSION HAZARD**

- Always confirm the UL 1604, ANSI/ISA 12.12.01 or CSA C22.2 N° 213 hazardous location rating of your device before installing or using it in a hazardous location.
- To apply or remove the supply power from a Smart 15" device installed in a Class I, Division 2 hazardous location, you must either:
 - Use a switch located outside the hazardous environment, or;
 - Use a switch certified for Class I, Division 1 operation inside the hazardous area.
- Do not connect or disconnect any cables or wires while the circuit is live unless the area is known to be free of ignitable concentrations of vapors, gases, and other flammable or combustible materials. This applies to all connections including power, ground, serial, parallel, and network connections.
- Never use unshielded/ungrounded cables in hazardous locations.
- Use only non-incendiary USB devices (*see page 79*).
- When enclosed, keep enclosure doors and openings closed at all times to avoid the accumulation of foreign matter inside the workstation.

Failure to follow these instructions will result in death or serious injury.

 **CAUTION****OVERTORQUE AND LOOSE HARDWARE**

- Do not exert more than 0.6 N•m (5.3 lb-in) of torque when tightening the installation fastener, enclosure, accessory, or terminal block screws. Tightening the screws with excessive force can damage the plastic casing of the Smart 15".
- When installing or removing screws, ensure that they do not fall inside the Smart 15" unit's chassis.

Failure to follow these instructions can result in injury or equipment damage.

 **CAUTION****STATIC SENSITIVE COMPONENTS**

Smart 15" internal components, including accessories such as RAM modules and expansion boards, can be damaged by static electricity. Observe the electrostatic precautions below when handling such components.

Failure to follow these instructions can result in injury or equipment damage.

Precautions to be taken:

- Keep static-producing materials (plastic, upholstery, carpeting) out of the immediate work area.
- Do not remove ESD-sensitive components from their anti-static bags until you are ready to install them.
- When handling static-sensitive components, wear a properly grounded wrist strap (or equivalent).
- Avoid unnecessary contact with exposed conductors and component leads with skin or clothing.

Removing the Smart Unit's Cover

How to Remove the Smart Unit's Cover

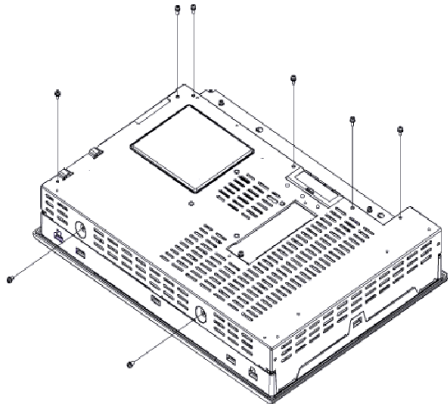
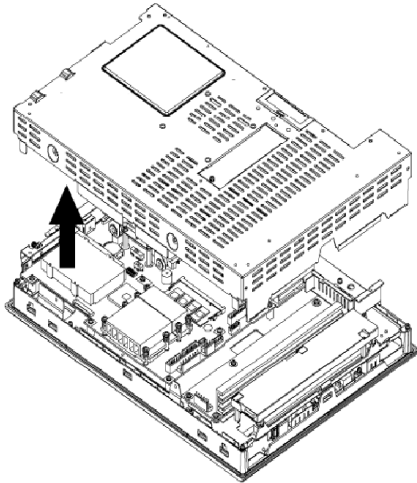
Step	Action
1	Shut down Windows® in an orderly fashion and remove all power from the device.
2	Place the unit on a clean, level surface with the display facing downwards. Place a soft, non-abrasive pad on the surface before placing the unit upon it.
3	Loosen the screws attaching the cover as shown below: 
4	Remove the cover as shown below: 

Smart 15" Internal View

Illustration

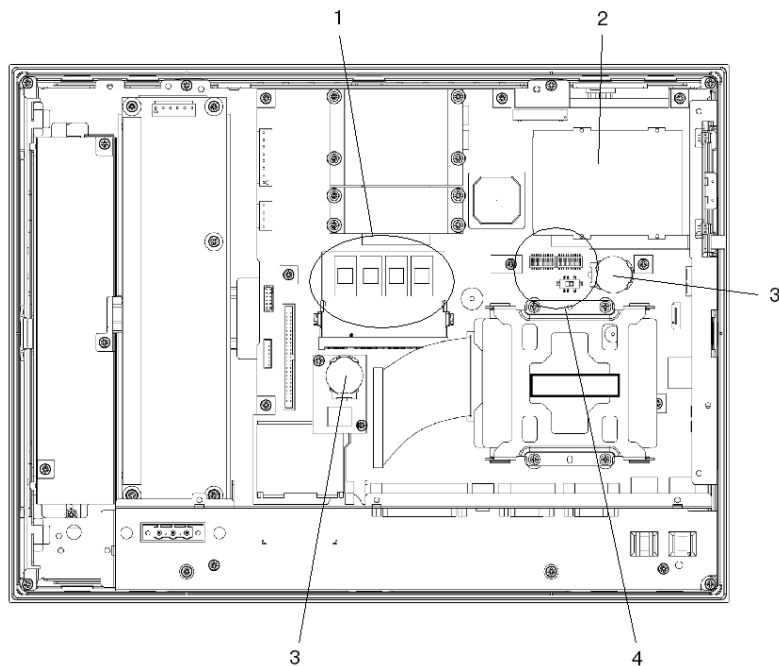

Description

Number	Description
1	Main Memory Installation Area
2	PCMCIA Slot (2 ports)
3	Battery
4	USB Front Face Setting Location (Activation/Deactivation)

USB Front Face

Enabled/Disabled State

DANGER

HAZARD OF ELECTRIC SHOCK, EXPLOSION OR ARC FLASH

Read and understand the safety information in the sections Before modifications (*see page 86*) and Removing the Smart's unit cover (*see page 89*) before attempting this procedure.

Failure to follow these instructions will result in death or serious injury.

In order to enable/disable the USB front face port, follow the procedure given below:

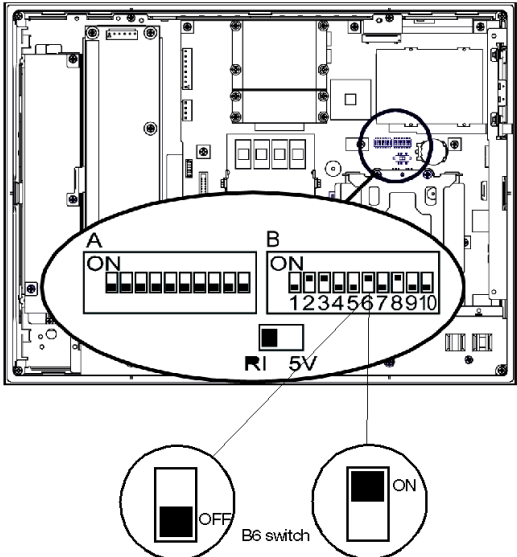
Step	Action
1	Shut down Windows® in an orderly fashion and remove all power from the device
2	Place the unit on a clean, level surface with the display facing downwards. Place a soft, non-abrasive pad on the surface before placing the unit upon it.
3	Remove the Smart's rear cover (see page 89)
4	<p>The figure below shows the switch (B6) on the mother board which enables/disables the state of the USB front face port:</p> 
5	When you have completed your adjustments to switch B6, confirm all switches are in their proper positions and replace the Smart unit's cover.

⚠ WARNING

UNINTENDED EQUIPMENT OPERATION

Before replacing the Smart's cover, confirm that all switches other than B6 are still in their default positions as indicated in the preceding figure.

Failure to follow these instructions can result in death, serious injury, or equipment damage.

PCMCIA Card Installation

Overview

Before installing or removing a PCMCIA card, shut down Windows® in an orderly fashion and remove all power from the device.

DANGER

HAZARD OF ELECTRIC SHOCK, EXPLOSION OR ARC FLASH

Read and understand the safety information in the section Before modifications (*see page 86*) before attempting this procedure.

Failure to follow these instructions will result in death or serious injury.

PCMCIA Cards with Cables

When using a PCMCIA card with an external cable attached, install a clamp or other type of device to secure the cable.

WARNING

EQUIPMENT DISCONNECTION OR UNINTENDED EQUIPMENT OPERATION

- Ensure that power, communication, and accessory connections do not place excessive stress on the ports. Consider the vibration environment when making this determination.
- Securely attach power, communication, and external accessory cables to the panel or cabinet.
- Use only commercially available USB cables.

Failure to follow these instructions can result in death, serious injury, or equipment damage.

NOTE: PCMCIA types are differentiated by their thickness:

- Type I: 3.3 mm (0.13 in)
- Type II: 5 mm (0.20 in)
- Type III: 10.5 mm (0.41 in)

Installing a Type I or Type II PCMCIA Card

The table below describes how to install a Type I or Type II PCMCIA Card:

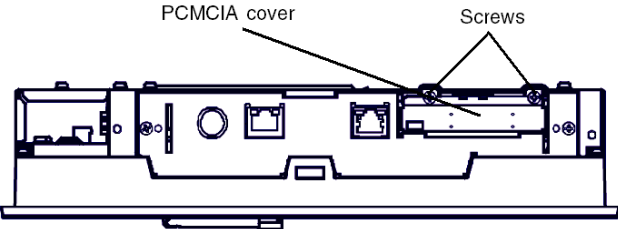
Step	Action
1	<p>To install a Type I or Type II PCMCIA card, loosen the screws on the side of the PCMCIA slot and move the cover to one side.</p>  <p>The diagram shows a side view of a PCMCIA slot. A cover is attached to the top edge of the slot. Two screws are shown on the right side of the cover, which are used to secure it. Labels 'PCMCIA cover' and 'Screws' point to these components.</p>
2	<p>Press the eject button twice. Insert the PCMCIA card into the lower slot and push it in until the PCMCIA pins mate with the slot connector pins.</p>

Installing a Type III PCMCIA Card

The table below describes how to install a Type III PCMCIA Card:

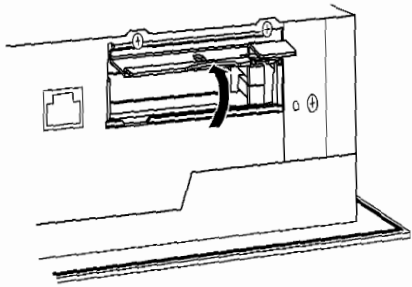
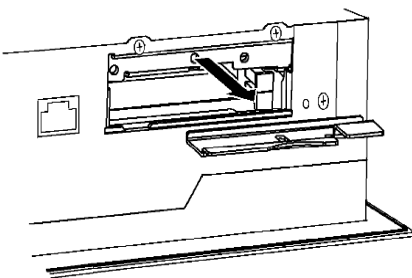
Step	Action
1	<p>To install a Type III PC card, unscrew the PCMCIA slot cover and remove the cover as shown below:</p> 
2	
3	<p>Press both eject buttons twice. Insert the PCMCIA card into the slots and push it in until the PCMCIA pins mate with the slots connector pins.</p>

Removing a PCMCIA Card

The table below describes how to remove a PCMCIA Card:

Step	Action
1	<p>To remove the PCMCIA card: Press both eject buttons twice (Pressing the eject buttons once causes the tip of the card to be exposed. Pressing the eject buttons a second time ejects the PCMCIA card from the slot). Withdraw the PCMCIA card.</p>
2	<p>Reposition the PCMCIA slot cover and tighten the screw.</p>

Compact Flash (CF) Card Installation and Removal

Preparing to use a CF Card

The Smart's operating system views the CF Card as a hard disk. Proper handling and care of the CF Card helps extend the life of the Card. Familiarize yourself with the Card prior to attempting insertion or removal of the Card.

CAUTION

COMPACT FLASH CARD DAMAGE AND DATA LOSS

- Remove all power before making any contact with an installed CF card.
- Use only CF cards manufactured by Schneider Electric. The performance of the Smart 15" has not been tested using CF cards from other manufacturers
- Confirm that the CF Card is correctly oriented before insertion.
- Do not bend, drop, or strike the CF card.
- Do not touch the CF card connectors.
- Do not disassemble or modify the CF card.
- Keep the CF card dry.

Failure to follow these instructions can result in injury or equipment damage.

DANGER

HAZARD OF ELECTRIC SHOCK, EXPLOSION OR ARC FLASH

Read and understand the safety information in the section Before modifications (*see page 86*) before attempting this procedure.

Failure to follow these instructions will result in death or serious injury.

Inserting the CF Card

The table below describes how to insert the CF Card.

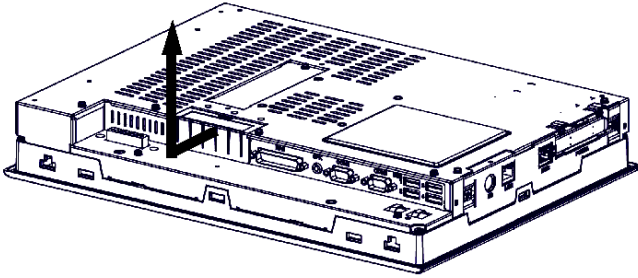
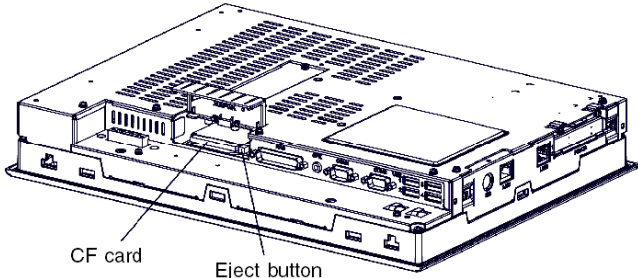
Step	Action
1	Shut down Windows in an orderly fashion and remove all power from the device.
2	Unscrew the CF Card cover's attachment screw, and remove the CF Card cover. 
3	Insert the CF Card firmly into the CF card slot, and check that the eject button pops out. 
4	Replace the CF Card cover and attach it in place with the screw. Note: The necessary torque is 0.5 to 0.6 N•m (4.5 to 5.3 lb-in).

Removing the CF Card

The table below describes how to remove the CF Card.

Step	Action
1	Shut down Windows® in an orderly fashion and remove all power from the device, then remove the CF card cover as described above.
2	Press the eject button in fully to remove the CF Card from the CF Card slot.
3	After inserting/removing the CF card, be sure to replace the CF Card cover and secure it in place using the attachment screw. Note: The necessary torque is 0.5 to 0.6 N•m (4.5 to 5.3 lb-in).

Data Writing Limitation

The CF Card is limited to approximately 100,000 write operations. Back up all CF Card data regularly to another storage media.

Backup of the CF Card Data

Refer to the relevant procedure in the Software Installation Guide for Magelis Industrial PC and Terminals.

USB Cable Clamp Attachment/Removal

Introduction

When using a USB device, attaching the USB cable with a clamp to the Smart unit's bridge (located on the side of the USB ports) prevents the USB device from becoming disconnected.

DANGER

HAZARD OF ELECTRIC SHOCK, EXPLOSION OR ARC FLASH

Read and understand the safety information on Before modifications (*see page 89*) and Removing the Smart's unit cover (*see page 89*) before attempting this procedure.

Failure to follow these instructions will result in death or serious injury.

WARNING

EQUIPMENT DISCONNECTION OR UNINTENDED EQUIPMENT OPERATION

- Ensure that power, communication, and accessory connections do not place excessive stress on the ports. Consider the vibration environment when making this determination.
- Securely attach power, communication, and external accessory cables to the panel or cabinet.
- Use only commercially available USB cables.

Failure to follow these instructions can result in death, serious injury, or equipment damage.

USB Cable Clamp Attachment

The table below describes how to attach the USB holder.

Step	Action
1	Shut down Windows® in an orderly fashion and remove all power from the device.
2	Place the unit on a clean, level surface with the display facing downwards. Place a soft, non-abrasive pad on the surface before placing the unit upon it.
3	<p>Insert the USB cable clamp's band through the bridge. Pass the USB cables through the cable clamp's band and securely tighten the clamp band around the cables.</p> <p>Notes:</p> <ul style="list-style-type: none">● When using two or more USB ports, be sure to first connect one USB cable to the lower USB connector, and then connect the second USB cable to the upper USB connector.● When using only one of the USB ports, be sure to use the lower USB connector. This allows you to securely clamp the USB cable in the cable clamp.● Be sure the clamp is securely holding the USB cable's plug and collar.● Be sure the clamp is positioned pointing upwards - not to the side. This is to keep the clamp from interfering with nearby connectors and their cables.

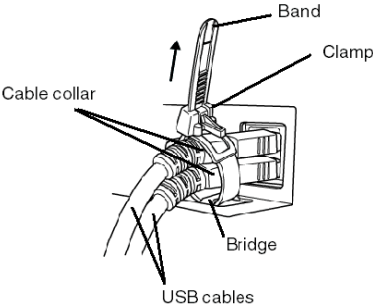

USB Cable Clamp Removal

The table below describes how to remove the USB cable clamp.

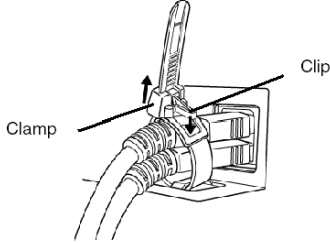
Step	Action
1	<p>To remove the clamp from the USB cables, push down on the clamp strap's clip to release it while pulling up on the clamp.</p>  <p>The diagram illustrates the removal of a USB cable clamp. It shows a hand pulling upwards on the clamp strap, while another hand pushes downwards on the clip. Labels 'Clamp' and 'Clip' point to the respective parts.</p>
2	Remove the USB cables.
3	Remove the clamp's band from the bridge.

Installation

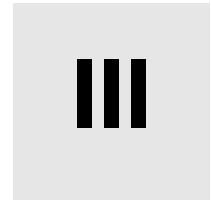

Subject of this Part

This part describes the product installation.

What's in this Part?

This part contains the following chapters:

Chapter	Chapter Name	Page
9	Connections to PLCs	105
10	System Monitoring	109
11	Maintenance	129
12	Troubleshooting	139

Connections to PLCs

9

Connection to PLCs

Introduction

Two different kinds of architectures are possible:

- Transparent Ready Architecture
- Traditional Architecture

Connections to Transparent Ready Architectures

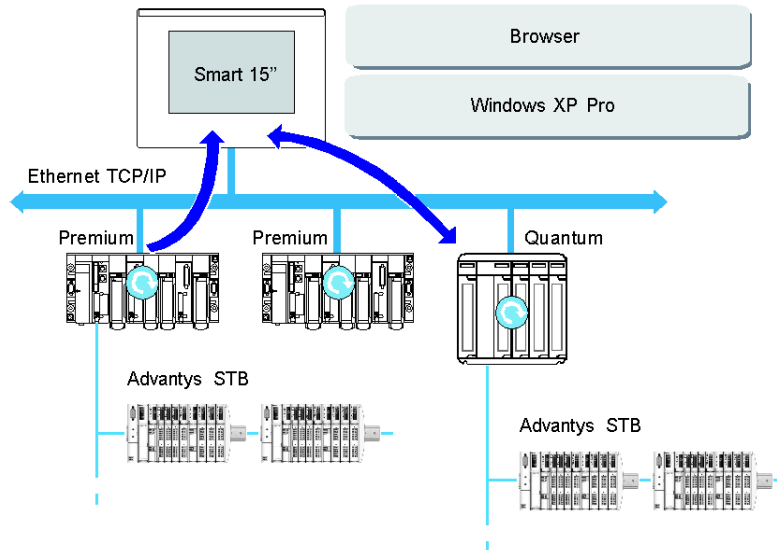

With its built-in Ethernet 10/100 Mbps ports, the Smart 15" can be integrated into *full Ethernet* architectures, such as Transparent Ready. Transparent Ready devices with this type of architecture enable transparent communication on the Ethernet TCP/IP network. Communication services and Web services permit the sharing and distribution of data between levels 1, 2 and 3 of the Transparent Ready architecture.

Used as a Client station, the Smart 15" makes it easier to implement Web Client solutions for:

- Basic servers embedded in field devices (Advantys STB/Momentum distributed I/O, ATV 71/38/58 starters, OsiSense identification systems, etc.).
- FactoryCast Web servers embedded in Modicon PLCs (TSX Micro, Premium and Quantum) or the FactoryCast gateway. The following services are available as standard (without the need for additional programming): alarm management, comprehensive view management and Web home pages created by users.
- FactoryCast HMI Web servers embedded in Modicon Premium and Quantum PLCs also provide basic data management services, automatic e-mail sending triggered by specific process events and arithmetic and logic calculations for data preprocessing.

HMI Applications in Traditional Architectures

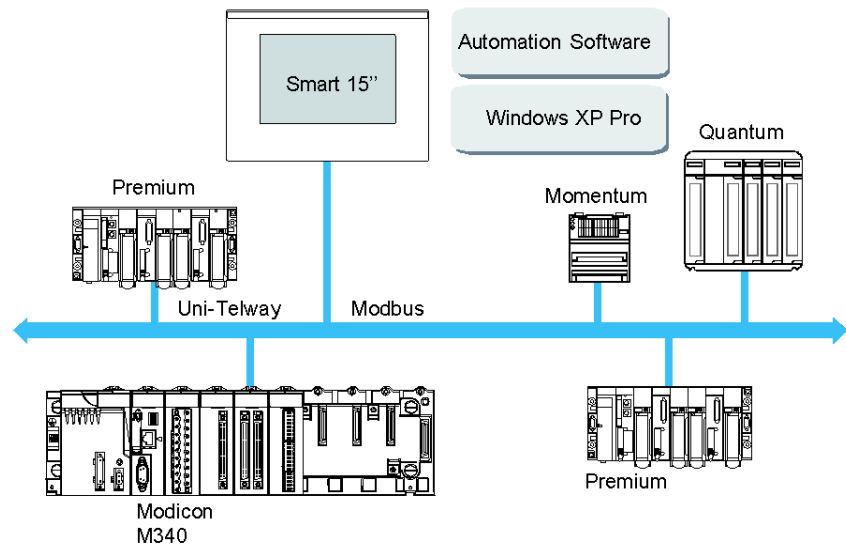

The Smart 15" terminal with Vijeo Designer control or automation software can be used in fieldbus architectures such as Uni-Telway/Modbus or Fipway/Modbus Plus.

The Smart 15" terminal can connect to Uni-Telway, Modbus, and Fipway networks, but different connection devices are required depending on the network and on the communication port used. These devices are specified below:

- For PCMCIA slot:
 - Fipway network with the PCMCIA card TSX FPP 20 (1).
 - Modbus Plus network with the PCMCIA card TSX MBP 100 or the PCI bus card 416 NHM 300 30.
 - Uni-Telway, with an RS 485 TSX SCP 114 card (1).
 - For a Modbus link, one of the built-in RS 232C COM ports is used.

- For USB slot:
 - Modbus and Uni-Telway with the TSXCUSB485 converter. It allows an iPC to be connected to remote devices using an RS 485 interface. This device, compatible with Modbus and Uni-Telway, requires the standard Schneider drivers provided with software such as UNITY, PL7-Pro or part of the CD driver TLXCDDR20M. An example is provided in the drawing below:

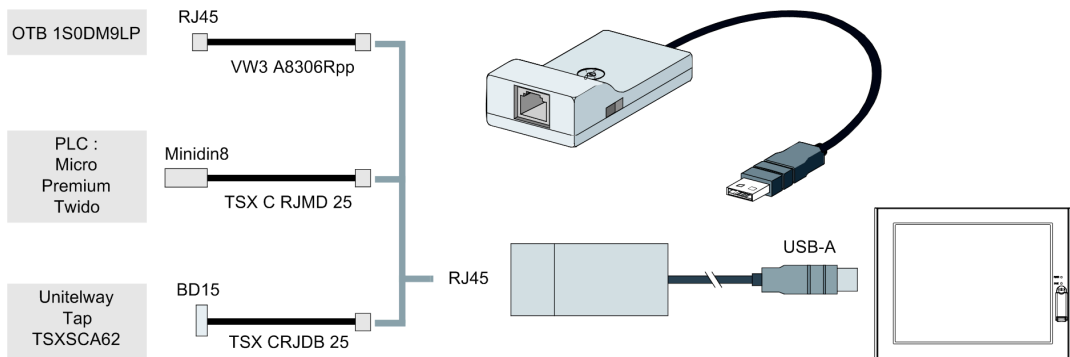

- Modbus Plus network with the TSXCUSBMBP converter. This converter is compatible with PCs equipped with CONCEPT, ProWORX or UNITY. Example on drawing below:

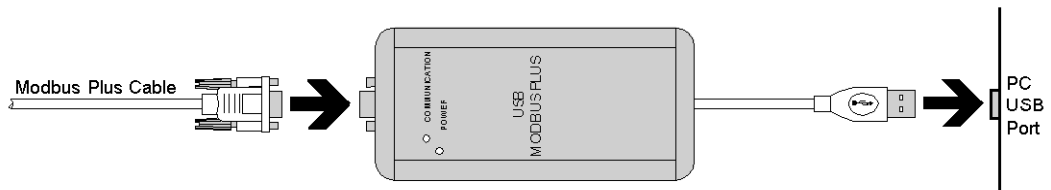

(1) Requires the *X-Way drivers* CD-ROM, TLX CD DRV20M.

Cables and Converters

For using the different types of PLCs, the following cables and converters are required:

- TSX PCX 1031 connection cable for Nano, Micro and Premium. This cable is supplied with Unity Pro, PL7 Pro and PL7 Junior software.
- FT20CBCL30 connection cable for the Series 7 family (included TSX 27 PLCs, and TSX/PMX 47/67/87/107 PLCs). This cable is supplied with the XTEL Pack software.
- TSX17ACCPC converter for TSX 17 LCs.

- TSXCUSB232 converter for connecting an iPC, via an USB port, to remote devices using an RS 232 interface.
This device, compatible with Modbus and Uni-Telway, requires the standard Schneider drivers provided with software such as UNITY, PL7-Pro or part of the CD driver TLXCDDR20M. An example is provided in the drawing below:

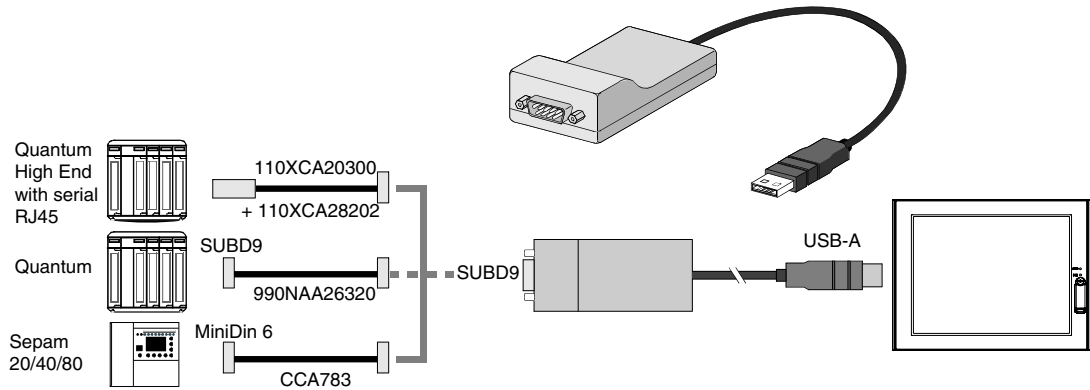

This device can be used as a PCMCIA port.

System Monitoring

10

Subject of this Chapter

This chapter describes the system monitoring and the RAS (reliability, availability and serviceability) features of the Smart.

What's in this Chapter?

This chapter contains the following topics:

Topic	Page
System Monitor Overview	110
System Monitor Property	117
System Monitor Interface	121

System Monitor Overview

Presentation

The System Monitor software enables you to monitor several system parameters (CPU temperature, normal operation of the miscellaneous voltages, normal operation of the backlight, normal operation of the hard disk...) as well as controlling the RAS I/O port.

The RAS I/O port is an interface that enables you to direct a remote reset of the Smart, operate a buzzer or perform other actions as noted in the section.

The System Monitor software alerts you if thresholds are exceeded via a popup message or a Windows alarm (in the Event Viewer). You can also configure actions to be undertaken: shutdown the Smart, restart the Smart, I/O activation...).

The software enables both system configuration (See System Monitor Property *(see page 117)*) and system operation (See System Monitor Interface *(see page 121)*).

System Monitor Architecture

The following figure shows the architecture of System Monitor:

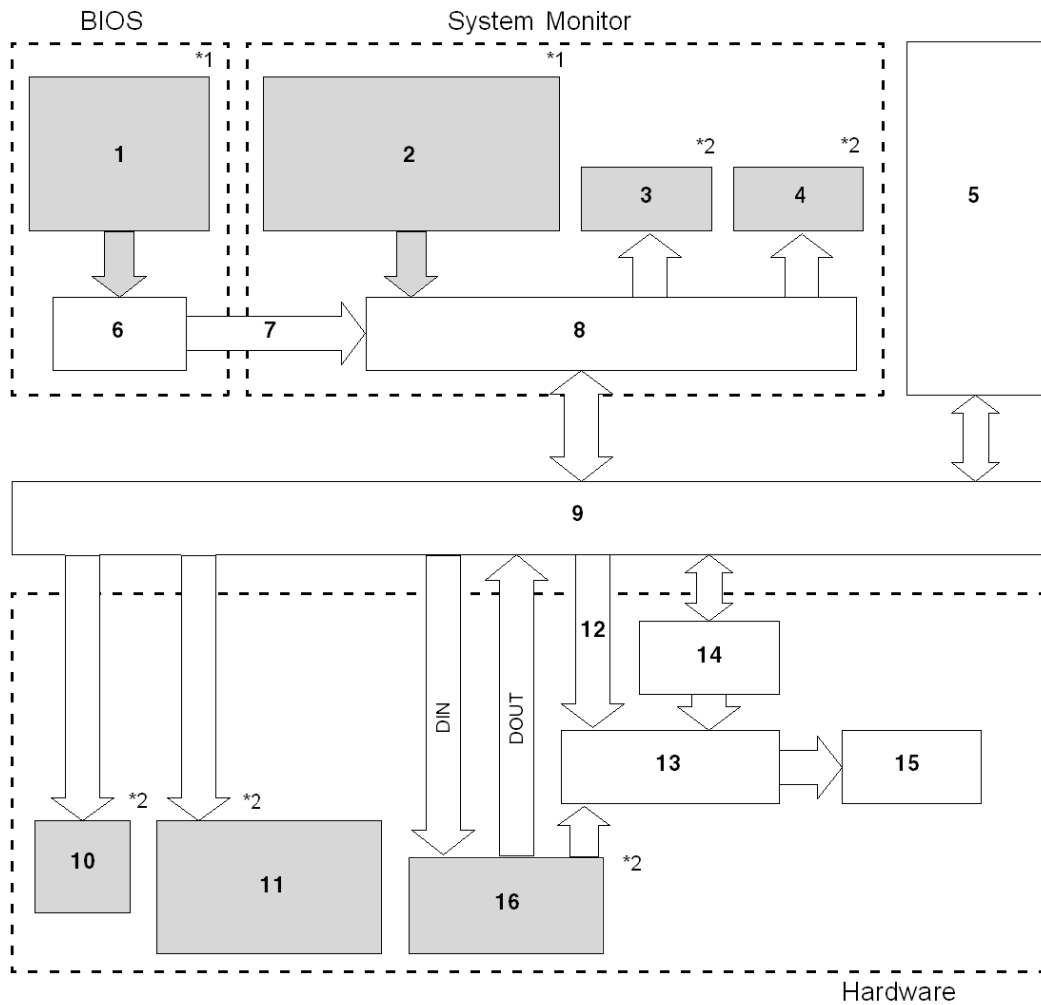

- 1 Bios Setup: Voltage, Temperature alarm, Detection Level Setting, Enable/Disable Settings
- 2 System Properties: Power alarm, Touch Panel Alarm, Output Settings, Watchdog Timer Value Settings, Watchdog Reset, Enable/Disable Settings
- 3 Popup Message
- 4 OS Shutdown
- 5 User Application
- 6 Bios
- 7 System Alarm Data

- 8 System Monitor Application
- 9 Driver or API-DLL
- 10 Buzzer
- 11 LED Green: Power On - LED Orange: RAS Error/Touch Panel Self Test Error - LED Orange/Red blinking: Backlight Error - LED Green Blinking: Soft OFF Status.
- 12 Watchdog Timer Reset, Mask settings
- 13 Reset Control
- 14 Watchdog Timer
- 15 Hardware Reset
- 16 RAS Connector: DIN (4 Ports), DOUT (4 Ports), RESET IN.

*1 Be sure to adjust these settings according to your system's specification.

*2 The RAS Software may be configured to provide these output alarms/signals.

RAS Features

RAS stands for Reliability, Availability and Serviceability. It is a device-level monitoring function that provides a variety of features to improve the reliability of the Smart 15" system.

Although the standard set of RAS features will vary depending on the devices used, the following features provide alarm monitoring and external input signal support.

Feature	Functions Supervised
Alarm Monitoring	Power Voltage Alarm
	Internal Temperature Alarm
	Watchdog Timer (System uptime)
	SMART Alarm
	Backlight Alarm
External Input Signal	General Purpose Signal Input *1 (DIN (4 ports)) Remote Reset Input *2 (1 lamp)

*1: An error message or other signal received on DIN1 (that is, a change of state on this input from 0 to 1 or 1 to 0) is stored in memory, and cannot be cleared by clicking on the Alarm dialog box generated by the System Monitor. The System Monitor software periodically checks the state of DIN1, and will display the Alarm dialog until the actual state of the DIN1 input reverts to the normal state. The other input alarms may be cleared by clicking on the Alarm dialog box.

*2: If the Remote Reset Input is disabled, DOUT cannot be configured to force a system reset.

The Smart's RAS software may be programmed to provide the following outputs when one of the alarms mentioned above occurs, or when an external input signal is received.

Feature	Functions Supervised
External Output Signal	General Purpose Signal Output (DOUT (4 ports))
Various Processing Functions	LED Indicator (3 colors, 1 lamp)
	Popup Message Output
	Buzzer Output
	System Shutdown
	System Reset

External Input Signals

The RAS interface connector of the Smart unit accepts the following input signals:

Feature	Functions Supervised
General Purpose Signal Input (DIN (4 ports))	This standard digital input is used for alarm detection in external devices. The input signal uses four bits. The System Monitor Property of the control panel or an API-DLL can be used to enable or disable this feature, as well as to designate what type of processing is to be performed once a signal is received. (Only the "ON" state of the DIN circuit is detected. The "OFF" state cannot be monitored).
Remote Reset Input	This is the reset signal sent from an external device to the Smart 15". When this signal is enabled, a forced reset of the Smart 15" is performed. <ul style="list-style-type: none"> ● Input Voltage: 12...24 Vdc ● Input Current: 10 mA ● Operating ON Voltage: 10 Vdc (min.) ● Operating OFF Voltage: 3 Vdc (max.) ● Isolation Method: Via Photocoupler

The RAS input circuits must be powered by an external DC power supply.

CAUTION

OVERCURRENT DAMAGE TO INPUTS

Use a protective impedance or other reasonable measures to limit the current to each input to 10 mA or less.

Failure to follow these instructions can result in injury or equipment damage.

The **Interface Circuit Diagram** is shown below:

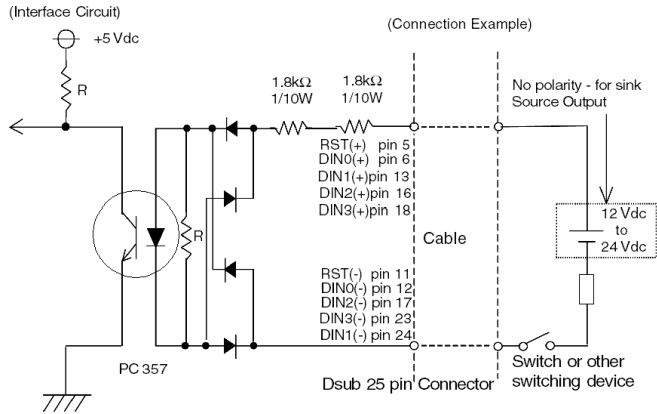

See RAS interface (see page 40) for details about cabling.

External Output Signals

The RAS interface connector on the Smart unit is prepared for the following output signals:

Feature	Functions Supervised
General Purpose Signal Output (DOUT (4 ports))	This general purpose digital output signal provides system condition information to external devices. The System Monitor Property of the control panel or the API-DLL is used by applications to control this signal. The system Monitor Property can be used to enable or disable any of these output signals.
External Output Signal (DOUT, common use with Alarm Output)	<ul style="list-style-type: none"> Rated Load Voltage: 12....24 Vdc Maximum Load Current: 120 mA/point Maximum Voltage Drop between Terminals: 1.5Vdc (at 100 mA load current) Isolation Method: Via Photocoupler

The RAS output circuits must be powered by an external DC power supply.

⚠ CAUTION

OVERCURRENT DAMAGE TO OUTPUTS

Use a protective impedance or other reasonable measures to limit the current to each output to 120 mA or less.

Failure to follow these instructions can result in injury or equipment damage.

The **Interface Circuit** Diagram is shown below:

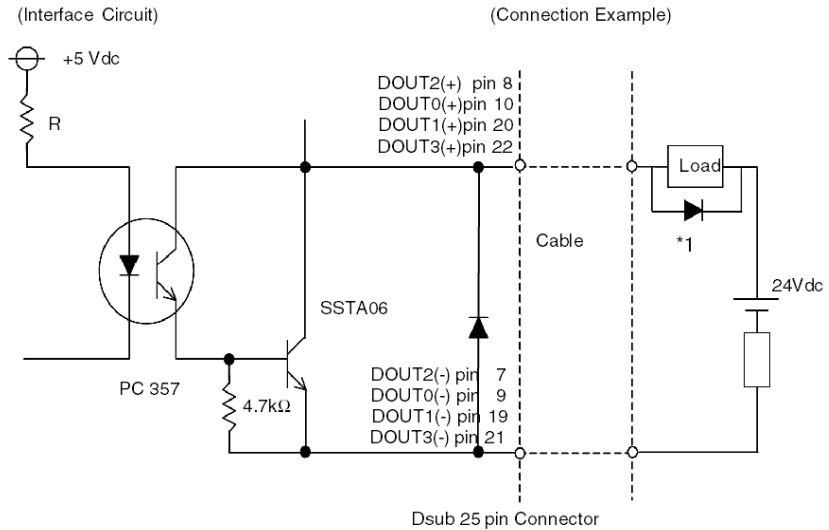

*1 When connecting an inductive load, be sure to use a flyback diode.
See RAS interface (see page 40) for details about cabling.

DLL Feature of System Monitor

System Monitor also includes a dynamic link library (API-DLL) feature that gives other applications access to the RAS features.

Accessing the System Monitor

You can monitor the system status at any time using the System Monitor interface. The procedure below shows how to access the System Monitor interface screen:

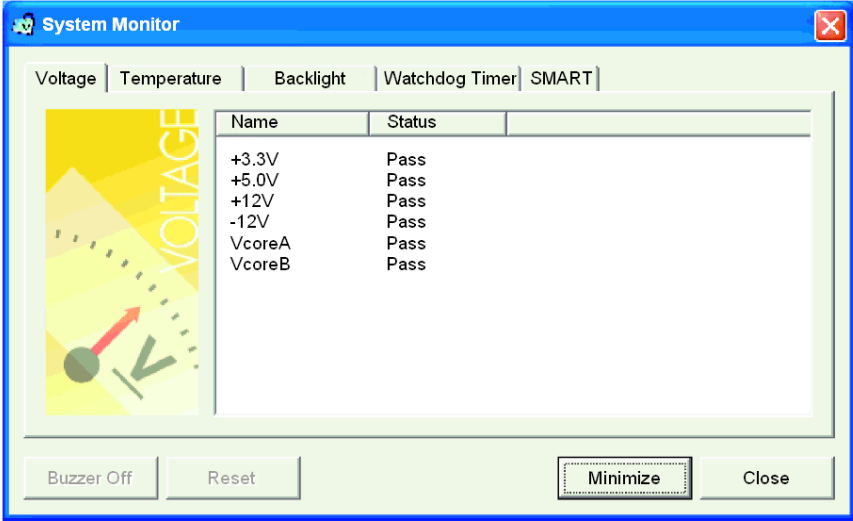
Step	Action
1	Start the Smart 15" operating system
2	<p>In the task bar, double-click the  icon.</p> <p>Result: The System Monitor GUI screen appears.</p> 

NOTE: If you cannot see the  icon in the task bar, launch the System Monitor software by double-clicking the **systemmonitor.exe** file located in the following path: *C:\schneider\sysmon\gui*.

System Monitor Property

Presentation

The System Monitor Property screen enables you to specify which system parameters you want to monitor and how you want to be alerted.

Accessing the System Monitor Property

The System Monitor Property screen enables you to configure the Smart system parameters you want to monitor and select how you want to be alerted. The procedure below shows how to access the System Monitor Property screen:

Step	Action
1	Start your Smart 15" operating system
2	Click Start → Control Panel . Result: The Control Panel window appears.
3	Double-click System Monitor Property . Result: The System Monitor Property window appears.

Setting up the System Monitor Properties

The following figure gives an overview of the System Monitor Property setting screen.

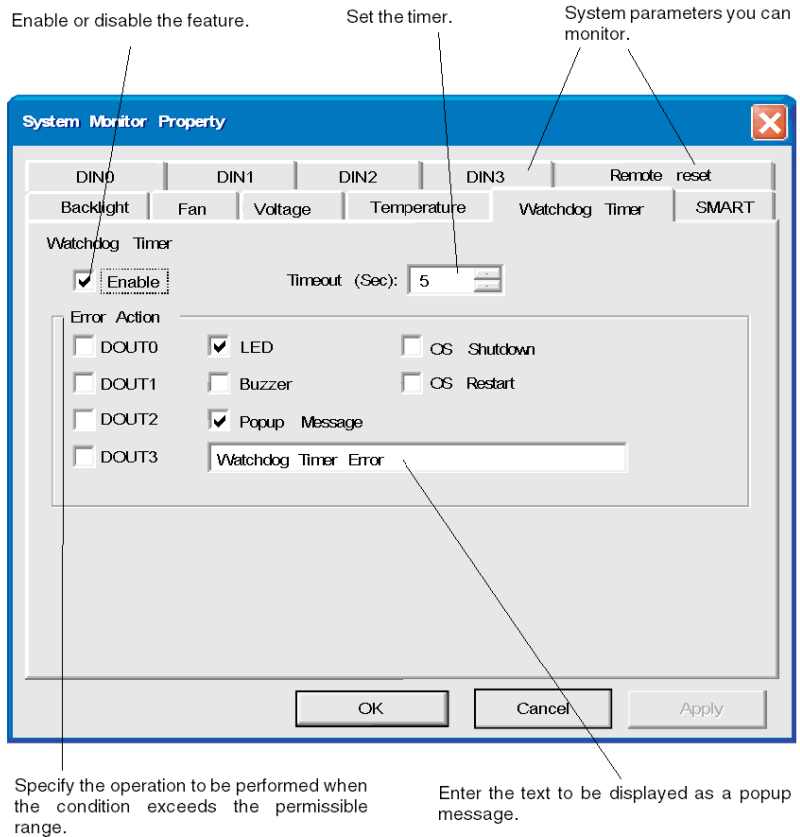

Click the tabs on the top of the screen to access the configuration page of each system parameter.

The table below describes the system parameters available for monitoring:

Feature	Functions Supervised
Voltage	Monitors the status of the Smart's built-in power supply and internal CPU power supply.
Temperature	Provides an alert when a dysfunction of the System, or the CPU, could appear (due to high temperature).

Feature	Functions Supervised
Backlight	Detects backlight alarms. When the backlight burns out, the power LED will flash orange/red (See Smart 15" Unit Description <i>(see page 32)</i>).
Watchdog Timer	This feature monitors the performance of the CPU by writing the uptime count value for the CPU to the built-in programmable timer of the RAS and by periodically clearing the count value from the CPU. Errors are detected when the clearing of the count values from the CPU stops. This causes a timer overflow.
SMART	Monitors the status of the hard drive. Detects degradation in hard disk performance and detects hard disk errors that may result in data loss or operating system corruption. Only available on Smart + Units and not available on Smart Units

NOTE: SMART monitoring:

A CF card does not support SMART and therefore the status of the CF card cannot be monitored on Smart units.

Once you know the system parameters you want to monitor, you can specify actions that will be undertaken when an event (timeout, value out of range...) occurs. Set the action to be performed when a System Monitor/RAS event occurs, by selecting the relevant check box.

The following table gives a description of the operations that can be performed:

Item	Action
Enable	Select or deselect this option to enable/disable monitoring feature.
Buzzer	Sound an electronic beep ("This option is automatically disabled" when a check is placed in the "OS shutdown" checkbox).
Popup Message	Display error messages as popup messages. (The monitoring item and description of the error are displayed).
Operating System Shutdown	Shutdown the operating system. (The shutdown confirmation message is not displayed).
Operating System Restart	Resets the hardware.
Power LED	The Power LED lights orange for an RAS alarm.
DOUT 0 to 3	Output from the RAS port.

Power LED Indicator

The three colors Power LED (See Smart 15" Unit Description (*see page 32*)) indicates the Smart system conditions. It is also a power ON/OFF indicator. The Power LED is located on the front face of the unit.

The Smart unit can send the following system status information to an external device:

Power LED Color	System Status	Output Condition
Green (Lit)	Normal operation (Power is ON)	None
Green (Blinking)	System is NOT running (Soft OFF). See Smart 15" Unit Description (<i>see page 32</i>).	None
Orange (Lit)	An RAS alarm has occurred	Power LED is enabled via System Monitor Property
	Touch Panel Self-Test Error	None
Orange/Red (Blinking)	Backlight is not functioning	None
Not Lit	Power is OFF	–

NOTE: If the orange Power LED of the Smart is illuminated immediately after the power is turned on, a Touch Panel Self-test Error may have occurred.

Features Availability

The following table lists the operating settings available for each feature:

O: Setting available - X: Setting not available

Feature	Operation					
	Buzzer	Popup Message	OS Shutdown	Reset	LED	DOUT0 to 3
Watchdog Timer	O	O	O	O	O	O
Voltage	O	O	O	X	O	O
Temperature	O	O	O	X	O	O
Backlight	O	O	X	X	O	O
DIN0 to 3	O	O	O	X	O	O

System Monitor Interface

Presentation

You can monitor the system status at any time using the System Monitor interface.

Description of the Interface

The following screen gives an overview of the System Monitor interface. Selecting each of the tabs displays the status of each item. When an error occurs, the color of the tab changes.

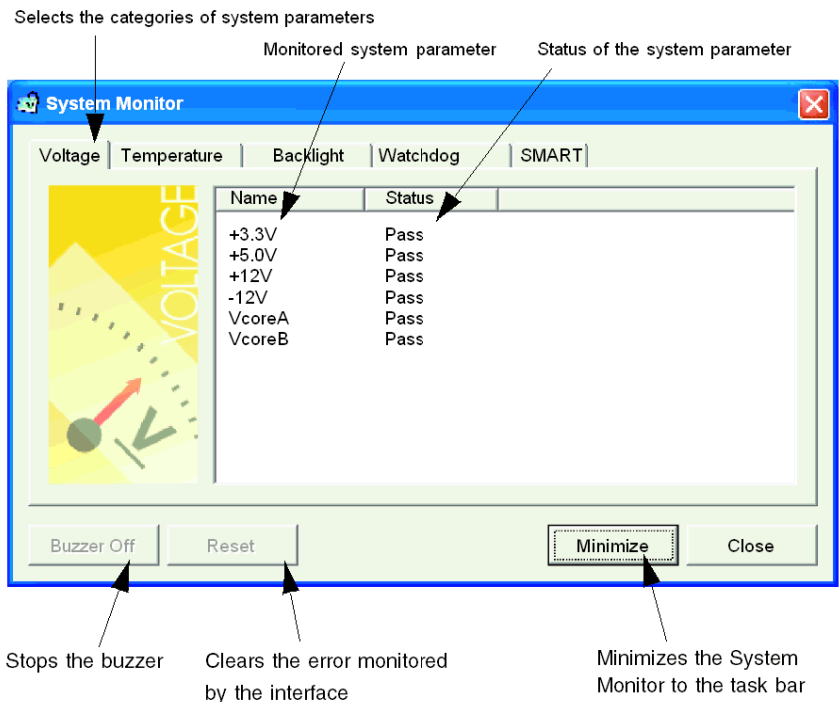

The System Monitor interface displays the status of the system parameters. The following table describes the messages provided by the System Monitor interface:

Display	Meaning
Pass	Normal
Fail	Abnormal (exceeds programmed limits)
Disabled	Monitoring disabled
Not Supported	Not supported

System Monitoring Operation

When an error is detected, the operations specified in the System Monitor Properties settings are performed (buzzer, popup message etc.) and an "X" is displayed on the icon in the system tray indicating an error status.

When the icon in the system tray changes as shown below, double-clicking the icon gives an explanation of the error condition.

System Monitor GUI icon when no event occurs



System Monitor GUI icon when a specified event occurs



The system performs the Error Action set in the System Monitor Properties when an error condition is detected with each monitoring item. The Error Action is performed only once when an error is detected for any of the items being monitored.

For example, look at the "+3.3 V" and "+5.0 V" options in the Voltage field. When the popup message feature for monitoring the voltage status is enabled, the popup message **+3.3 V Power Supply Error** is shown on the screen if a +3.3 V power supply error occurs. Press the **OK** button on the dialog box to hide the message.

Example of +3.3 V Power Supply error:

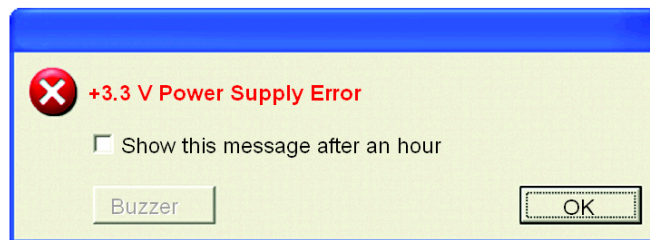

If a +5.0 V power supply error occurs, the popup message **+5.0 V Power Supply Error** is shown on the screen. The popup message displays the monitored item and an error description. When the buzzer feature is enabled, press the **Buzzer Off** button on the popup message to stop the buzzer sound. Press the **OK** button to close the popup message.

When OS Shutdown is enabled, the system automatically enters the shutdown operation without prompting the user for confirmation. To display the System Monitor screen for reviewing the present condition and the Smart's system date and time, double click on the icon in the System Tray.

When the buzzer sounds as an error action, the System Monitor screen displays the **Buzzer Off** button that is hidden during normal operation. When a popup message window is displayed, the **Buzzer Off** button is displayed in the window.

NOTE: Once an error is detected, the System monitor stores the error status (displays the icon indicating an error status). To resolve the error, press the **Reset** button on the System Monitor screen or switch off the Smart 15", perform the actions necessary to remove the cause of the error and power up the Smart 15" once more.

System Monitor Error Messages

This section describes the error messages and closing messages displayed on the System Monitor and System Monitor Property screens.

When an error occurs while the popup message option is enabled for Error Action, the following messages appear on the popup message output screen under the factory settings.

List of the error messages:

Error Generating Item	Message
VcoreA	VOLT VcoreA Power Supply Error
VcoreB	VOLT VcoreB Power Supply Error
Voltage +3.3 V	VOLT +3.3 V Power Supply Error
Voltage +5.0 V	VOLT +5.0 V Power Supply Error
Voltage +12 V	VOLT +12 V Power Supply Error
System Temperature	TEMP System Temperature Error
CPU Temperature	TEMP CPU Temperature Error
DIN0	DIN0
DIN1	DIN1
DIN2	DIN2
DIN3	DIN3
Watchdog Timer	Watchdog Timer Error
Backlight	Backlight Error

Example of displayed screen:

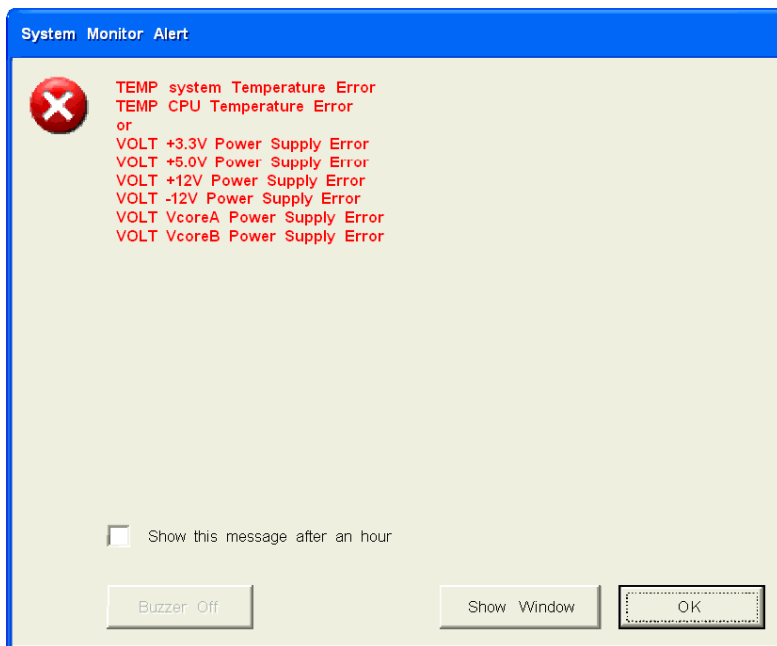

NOTE: You can modify the messages displayed on the popup message from the System Monitor Property screen.

Error Displays when Using the Event Viewer

The System Log records error type/location and error actions as error events. You can check the error event information using the Event Viewer.

Step	Action
1	Start your Smart terminal
2	Click Start → Control Panel → Administrative Tools → Event Viewer

NOTE: This feature is supported by Windows® XPe.

Error Type/Location and Error Action

The error type/locations shown by the Event Viewer are shown in the table below:

Error type/Location	Error Message Description
VcoreA	VOLT VcoreA Error has occurred
VcoreB	VOLT VcoreB Error has occurred
Voltage +3.3 V	VOLT +3.3 V Error has occurred
Voltage +5.0 V	VOLT +5.0 V Error has occurred
Voltage +12 V	VOLT +12 V Error has occurred
Voltage -12 V	VOLT -12 V Error has occurred
System Temperature	TEMP System Error has occurred
CPU Temperature	TEMP CPU Error has occurred
DIN0	DIN0 Error has occurred
DIN1	DIN1 Error has occurred
DIN2	DIN2 Error has occurred
DIN3	DIN3 Error has occurred
Watchdog Timer	Watchdog Timer Error has occurred
Backlight	Backlight Error has occurred

The actions taken when an error occurs and which are shown by the Event Viewer, are shown in the table below.

Type of Alert	Error Message
Buzzer	Buzzer has sounded because of an "xx" error.
Popup Message	Popup message has been shown because of an "xx" error.
OS Shutdown	Windows® has been shutdown due to an "xx" error.
DOUT0	DOUT0 has output because of "xx" error.
DOUT1	DOUT1 has output because of "xx" error.
DOUT2	DOUT2 has output because of "xx" error.
DOUT3	DOUT3 has output because of "xx" error.

NOTE:

- The data shown in the table uses "xx" to indicate the error type/location
- The actions taken by the system after an error occurs are set via the System Monitor Property screen.
- When a +3.3 V error occurs and the buzzer sounds, two errors will be displayed by the Event Viewer: **+3.3 V Error has occurred** and **Buzzer has sounded because of a +3.3 V error.**

Smart tab interface

The following figure shows an overview of the Smart monitoring screen:

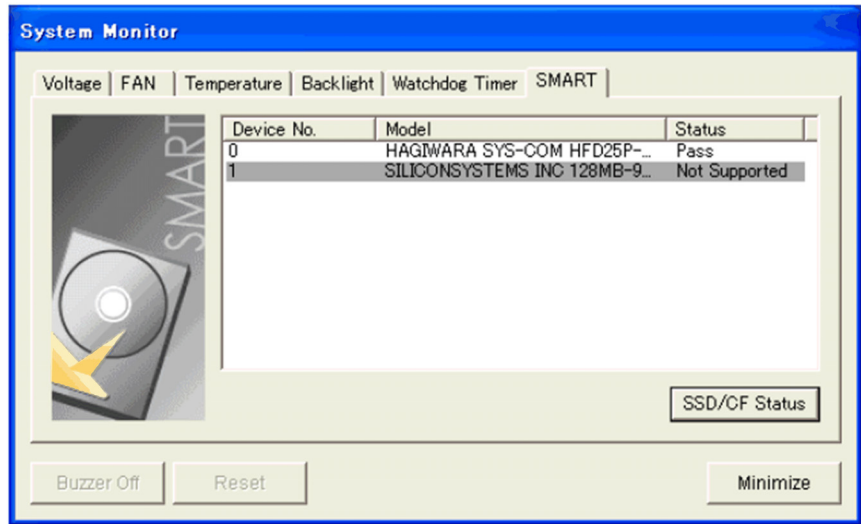

The following table gives a description of the operations that can be performed.

Item	Operation
Device No.	Displays the number assigned to the hard disk/SSD/CF card to be monitored
Model	Displays the model of the hard disk/SSD/CF card.
Status	Specifies the item to be monitored. The status of each monitoring item is displayed. [Pass]: Normal [Error]: Abnormal [Disable]: Not monitored [Not Supported]: Not supported NOTE: [Not Supported] is displayed when a drive that does not support SMART monitoring is detected.

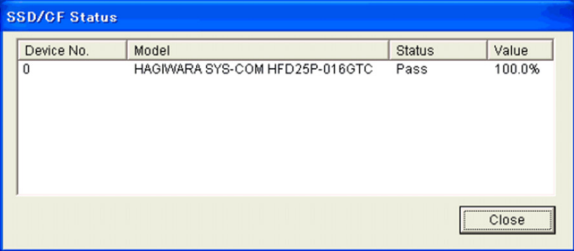
Item	Operation
SSD/CF Status	<p>Selecting [SSD/CF Status] displays the [SSD/CF Status] dialog box, which allows confirmation of remaining product life. Remaining product life is calculated according to the number of write operations made to the SSD, and is displayed as a percentage value with one decimal place.</p>  <p>NOTE: When remaining life becomes 0.0%, the error set in [Error Action] under [System Monitor Property] is generated.</p> <p>When the remaining life reaches 0.0%, order from Schneider service the replacement of the SSD unit with a new one.</p>
Buzzer Off	<p>When [Buzzer] is selected for the error notification method, you can stop the buzzer by clicking [Buzzer Off].</p>
Reset	<p>When an error is detected, clicking [Reset] recovers the System Monitor from the “error” status.</p> <p>NOTE: Ater an error is resolved, make sure to reset. If reset is not performed, the error history remains, which causes the error to be detected again even if it was resolved.</p>
Minimize	<p>Stores the System Monitor screen in the task tray.</p>

Maintenance

11

Subject of this Chapter

This chapter covers maintenance of the Smart 15".

What's in this Chapter?

This chapter contains the following topics:

Topic	Page
Reinstallation Procedure	130
Regular Cleaning and Maintenance	133

Reinstallation Procedure

Introduction

In certain cases, it may be necessary to reinstall the operating system.

DANGER

HAZARD OF ELECTRIC SHOCK, EXPLOSION, OR ARC FLASH

- Remove all power from the device before removing any covers or elements of the system, and prior to installing or removing any accessories, hardware, or cables.
- Always use a properly rated voltage sensing device to confirm power is off.
- Unplug the power cable from both the Smart unit and the power supply.
- Replace and secure all covers or elements of the system before applying power to the unit.
- Use only the specified voltage when operating the Smart 15". The AC unit is designed to use 100...240 Vac input. The DC unit is designed to use 23 ... 25 Vdc. Always check whether your device is AC or DC powered before applying power

Failure to follow these instructions will result in death or serious injury.

DANGER

CHEMICAL BURNS TO EYES OR SKIN

- Do not use tools to operate the touch panel or in the vicinity of the display.
- When placing the display face-down, select a clean, level, non-abrasive surface. Place a soft, non-abrasive pad on the surface before lowering the unit upon it.
- If a leak in the LCD panel is discovered, and you come in contact with the liquid crystal material, follow these procedures:
 - In the case of contact with eyes or mouth, flush with running water for 15 minutes minimum.
 - In the case of contact with skin or clothing, wipe off the liquid crystal material and wash soap and running water for 15 minutes
 - If liquid crystal is ingested, induce vomiting, rinse mouth, and then drink a large quantity of water.
 - Follow any other hazardous substances safety procedures required by your facility.

Failure to follow these instructions will result in death or serious injury.

 **DANGER****EXPLOSION HAZARD**

- Always confirm the UL 1604, ANSI/ISA 12.12.01 or CSA C22.2 N° 213 hazardous location rating of your device before installing or using it in a hazardous location.
- To apply or remove the supply power from a Smart 15" device installed in a Class I, Division 2 hazardous location, you must either:
 - Use a switch located outside the hazardous environment, or;
 - Use a switch certified for Class I, Division 1 operation inside the hazardous area.
- Do not connect or disconnect any cables or wires while the circuit is live unless the area is known to be free of ignitable concentrations of vapors, gases, and other flammable or combustible materials. This applies to all connections including power, ground, serial, parallel, and network connections.
- Never use unshielded/ungrounded cables in hazardous locations.
- Use only non-incendiary USB devices (*see page 79*).
- When enclosed, keep enclosure doors and openings closed at all times to avoid the accumulation of foreign matter inside the workstation.

Failure to follow these instructions will result in death or serious injury.

 **CAUTION****OVERTORQUE AND LOOSE HARDWARE**

- Do not exert more than 0.6 N•m (5.3 lb-in) of torque when tightening the installation fastener, enclosure, accessory, or terminal block screws. Tightening the screws with excessive force can damage the plastic casing of the Smart 15".
- When installing or removing screws, ensure that they do not fall inside the Smart 15" unit's chassis.

Failure to follow these instructions can result in injury or equipment damage.

 **CAUTION****STATIC SENSITIVE COMPONENTS**

Smart 15" internal components, including accessories such as RAM modules and expansion boards, can be damaged by static electricity. Observe the electrostatic precautions below when handling such components.

Failure to follow these instructions can result in injury or equipment damage.

Precautions to be taken:

- Keep static-producing materials (plastic, upholstery, carpeting) out of the immediate work area.
- Do not remove ESD-sensitive components from their anti-static bags until you are ready to install them.
- When handling static-sensitive components, wear a properly grounded wrist strap (or equivalent).
- Avoid unnecessary contact with exposed conductors and component leads with skin or clothing.

Before Reinstallation

Hardware required:

- Reinstallation CD-ROM
- A computer running Windows 2000/XP able to read "Compact Flash Memory" and having a CD-ROM drive.

Optimal configuration: Standard computer with PCMCIA slot (Notebook for example) and "Compact Flash" to PCMCIA adaptor.

Possible configuration: Computer and "Compact Flash reader" on USB port.

Setting up the hardware:

- Shut down Windows® in an orderly fashion and remove all power from the device. Then, follow the applicable instructions in **Removing the Smart's unit covert** (*see page 89*).
- Remove all PCMCIA extension boards.
- Disconnect all external peripherals.

NOTE: Save all important data on the hard drive or Compact Flash card (the reinstallation process erases all data on them). The reinstallation process will return the computer to its factory settings.

Reinstallation

Refer to the relevant procedure in the Installation Guide.

Regular Cleaning and Maintenance

Cleaning Solutions

CAUTION

HARMFUL CLEANING SOLUTIONS

- Do not clean the unit or any component of the unit with paint thinner, organic solvents, or strong acids.
- Use only a mild soap or detergent that will not harm the polycarbonate material of the screen.

Failure to follow these instructions can result in injury or equipment damage.

Installing a Replacement Gasket

Installation Gasket

Use of the installation gasket may help extend the operating life of your Smart. The gasket is required to meet the protection ratings (IP65, NEMA4, IP20) of the unit and provides additional protection from vibration. Even if moisture protection is not required, install the gasket delivered with your Magelis product.

CAUTION

LOSS OF SEAL

- Inspect the installation gasket prior to installation or reinstallation, and periodically as required by your operating environment.
- Replace the gasket if visible scratches, tears, dirt, or excessive wear are noted during inspection.
- Do not stretch the gasket unnecessarily or allow the gasket to contact the corners or edges of the frame.
- Ensure that the gasket is fully seated in the installation groove.
- Install the Smart into a panel that is flat and free of scratches or dents.
- Tighten the installation fasteners using a torque of 0.5 N•m (4.5 lb-in).

Failure to follow these instructions can result in injury or equipment damage.

The corresponding gasket is provided in the maintenance kit ref: MPC YK 50 MNT KIT.

Installation Fasteners

⚠ CAUTION

OVERTORQUE AND LOOSE HARDWARE

- Do not exert more than 0.6 N•m (5.3 lb-in) of torque when tightening the installation fastener, enclosure, accessory, or terminal block screws. Tightening the screws with excessive force can damage the plastic casing of the Smart 15".
- When installing or removing screws, ensure that they do not fall inside the Smart 15" unit's chassis.

Failure to follow these instructions can result in injury or equipment damage.

NOTE: The screw installation fasteners are required for NEMA4 protection.

The following procedure describes how to replace the installation gasket.

Step	Action
1	Shut down Windows® in an orderly fashion, remove all power from the device.
2	Place the unit on a clean, level surface with the display facing downwards. Place a soft, non-abrasive pad on the surface before placing the unit upon it.
3	Remove the gasket from the unit.
4	Attach the new gasket ensuring that the gasket's grooved sides are vertical. Ensure that the gasket's seam is not inserted into any of the corners of the unit as this may lead to tearing of the gasket.

The diagram consists of three parts: 1) A perspective view of the Smart 15" unit with a gasket being removed from its top surface. 2) A close-up view of the gasket being inserted into a groove on the unit's casing, with labels 'Gasket' and 'Installation Groove'. 3) A close-up view of the gasket itself, showing a horizontal line representing the 'Gasket Seam'.

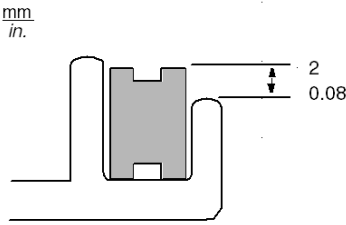
Step	Action
5	<p>Check that the gasket is correctly attached to the unit. The upper surface of the gasket should evenly protrude approximately 2 mm (0.08 in) out of the groove.</p> 
6	Replace the Smart unit on its mounting and reconnect the power.

Lithium Battery

⚠ DANGER

HAZARD OF ELECTRIC SHOCK, EXPLOSION, OR ARC FLASH

Read and understand the safety information in the Reinstallation procedure (see page 130) before attempting this procedure.

Failure to follow these instructions will result in death or serious injury.

⚠ DANGER

EXPLOSION, FIRE, OR CHEMICAL HAZARD

Follow these instructions for the Lithium batteries:

- Do not recharge, disassemble, heat above 100 °C (212 °F), or incinerate.
- Recycle or properly dispose of used batteries.
- Replace with identical type.
- Follow all battery manufacturer's instructions

Failure to follow these instructions will result in death or serious injury.

The terminal contains one battery, which is used to save certain system data such as the date and time.

Battery Replacement

The following tables gives the Battery replacement procedure:

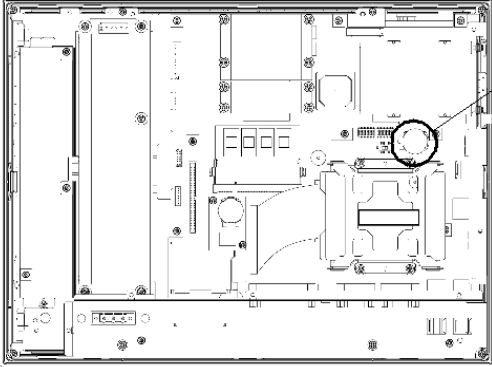
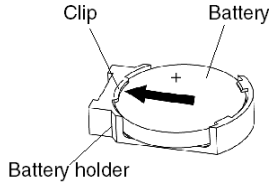
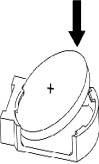
Step	Action
1	Shut down Windows in an orderly fashion, remove all power from the device.
2	Remove the Smart unit from its mounting, place it on a flat level surface with the display facing downwards, and follow the procedure to remove the Smart's unit cover Removing the Smart's Unit cover (see page 89).
3	Remove the battery which is in the location shown below: <div style="text-align: right; margin-top: 10px;">  <p>Internal battery</p> </div>
4	Push the clip of the battery holder and the battery is pushed up and removed. <div style="text-align: center; margin-top: 10px;">  </div>
5	Insert the battery in the side of the clip of the battery holder first with the plus (+) pole facing upward. <div style="text-align: center; margin-top: 10px;">  </div> <p>Push the battery from above until you hear the click to fit it in the battery holder.</p>
6	Replace the Smart's unit cover.
7	Replace the Smart unit on its mounting and reconnect the power.

Periodic Inspection

Be sure to inspect the Smart periodically to determine its general condition. For example:

- Are all power cords and cables connected properly? Have any become loose?
- Are all mounting brackets holding the unit securely?
- Is the ambient temperature within the specified range?
- Are there any scratches or traces of dirt on the installation gasket?

Troubleshooting

Troubleshooting Checklist

This section explains how to find and resolve troubleshooting items with the Smart unit.

The Smart can be connected to a wide range of devices, including a host (PLC), however, this manual will not discuss every possible device or condition. For problems not directly related to the Smart unit, refer to that device's manual.

The most likely items for troubleshooting that can occur during usage of the Smart are:

- The Touch Panel display is blank
- The Touch Panel does not respond
- Connected devices cannot be used.

When one occurs, be sure to first read each checklist item and follow the instructions given. If this does not solve the problem, please contact your local Smart distributor.

When a hardware or software issue occurs that you cannot resolve, please contact the distributor where you purchased the Smart unit.

No Display

Step	Check Item or Operation	Check Result	Action Required
1	Switch OFF the Smart power supply.		
2	Is the power cord connected correctly?		Connect the power cord correctly.
3	Is the power supply voltage within specification?		Please refer to Power supply (see page 44)
4	Switch ON the power supply.		
5	Does the ON LED illuminate in green?		Power indicator does not light up or is orange/red blinking and you have no screen operation, contact the distributor where the Smart was purchased.
6	Does the Windows® operating system work normally?		If a white screen is displayed and Windows® does not work at all, please contact the distributor where the Smart was purchased.
–	Has the issue been resolved?		If not, please contact the distributor where the Smart was purchased.



Touch Panel does not Respond

Step	Check Item or Operation	Check Result	Action Required
1	Has the Touch Panel been calibrated?		Calibrate the Touch Panel (See the procedure "Touch Panel Calibration" given below). If the Touch Panel cannot be calibrated, please contact the distributor where the Smart was purchased.
–	Has the issue been resolved?		If not, please contact the distributor where the Smart was purchased.

Touch Panel Calibration

You have two possible procedures to calibrate the Touch Panel.

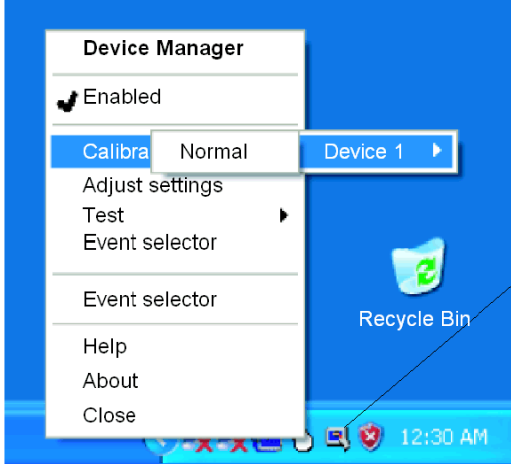
First procedure:

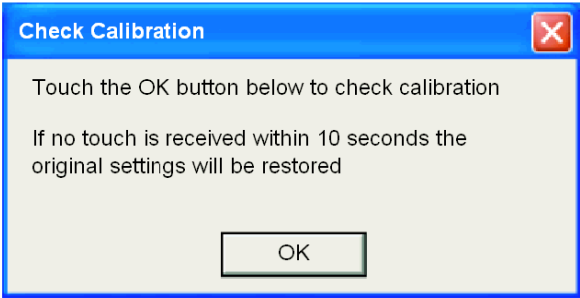
Step	Actions for procedure 1
1	<p>Click on the Touch Panel icon. Select 'Calibration', then 'Device 1'.</p>  <p>Touch Panel icon</p>
2	<p>An arrow appears in the upper left corner of the Touch Panel: touch the red point with your finger. Do the same for the four corners.</p> 
3	<p>In order to validate the calibration, click on OK in the following window:</p> 

Second procedure:

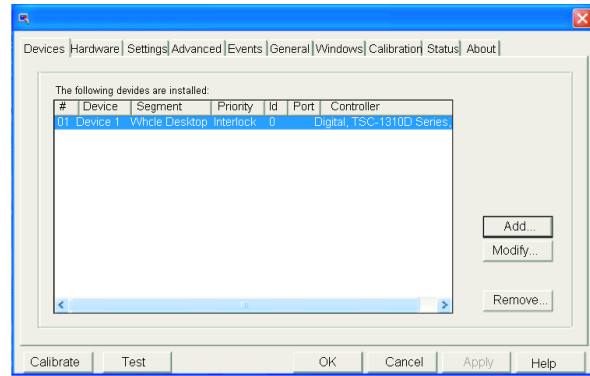
Step	Actions for procedure 2
1	Open the 'Control panel' window.
2	Click on the 'Pointer Devices' icon. 
3	In the following window, click on 'Calibrate' (bottom left): 
4	Then follow steps 2 and 3 of the previous table.

Connected Devices cannot be Used

Step	Check Item or Operation	Check Result	Action Required
1	Switch OFF the Smart power supply.		
2	Is the power cord connected correctly?		Connect the power cord correctly.
3	Are the peripheral devices connected correctly?		Follow the instructions described in the respective manual.
4	Switch ON the Smart power supply.		
5	Does this device require driver setup?		Refer to the device's manual and setup the driver.
–	Has the issue been resolved?		If not, please contact the distributor where the Smart was purchased.

Recovery

Please refer to the **Reinstallation Procedure** (see page 130)

Appendices



IV

Accessories

13

Accessories for the Smart 15"

List

Accessories are available as options. The list of accessories available for the Smart 15" is shown below:

Description	Reference
Maintenance Kit including installation fasteners, installation screws and gasket	MPC YK50 MNT KIT

Index

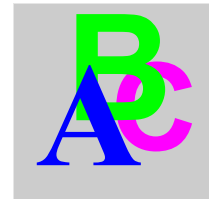

A

Accessing the BIOS, *81*
Accessories for the Smart 15", *145*

B

Backup of the CF Card Data, *98*
Before Modifications, *86*

C

Characteristics, *47*
Characteristics of the Smart 15", *44*
Cleaning and Maintenance, *133*
Compact Flash (CF) Card Installation and Removal, *96*
Connecting the AC Power Cord, *77*
Connecting the DC Power Cord, *73*
Connection to PLCs, *105*

- Cables and Converters, *107*
- Traditional Architectures, *106*
- Transparent Ready Architectures, *105*

Control Drawing of the USB outlet on the Magelis iPC, *79*

D

Data Writing Limitation, *98*
Dedicated Ground, *68*
Dimensions, *50*
Dimensions of the Smart Unit, *50*
Dimensions with Installation Fasteners, *52*

Display Characteristics, *44*

E

Environmental Characteristics, *48*
Exit BIOS saving the Modifications, *84*
Exit BIOS Without Saving Modifications, *84*
Extended Memory, *82*

F

First Power-up, *63*
Flash Disk Characteristics, *47*

G

Grounding, *68*

H

Hazardous Location Installations - For USA and Canada, *23*

I

- Inserting the CF Card, *97*
- Installation Location, *53*
- Installing a Replacement Gasket, *133*
- Installing a Type I or Type II PCMCIA Card, *94*
- Installing a Type III PCMCIA Card, *95*
- Installing the Smart Unit, *57*
- Items, *30*

L

- Lithium Battery, *135*

M

- Main Menu, *81*

O

- Operating Systems, *46*

P

- Package Contents, *30*
- Panel Cut Dimensions, *54*
- Panel Mounting, *53*
- Password Security, *83*
- PCMCIA Card Installation, *93*
- Periodic Inspection, *137*
- Power Supply, *45*
- Preparing to Install the 15" Smart, *55*
- Preparing to use a CF Card, *96*
- Primary Master, *82*
- Primary Slave, *82*
- Product Characteristics, *44*

R

- Reinstallation Procedure, *130*
- Removing PCMCIA Card, *95*
- Removing the CF Card, *98*

S

- Shared Ground - Avoid Ground Loop, *69*
- Shared Ground Allowed, *69*
- Shared Ground not Allowed, *69*
- Smart 15" Unit Description, *32*
- Supervisor Password, *83*
- System Date, *82*
- System Memory, *82*
- System Monitor
 - access, *117*
 - configuration, *117*
 - access, *116*
 - interface, *121*
 - overview, *110*
- System Monitor Overview, *110*
- System Monitor Property, *117*
- System Time, *82*

U

- USB Cable Clamp Attachment, *100*
- USB Cable Clamp Attachment/Removal, *99*
- USB Cable Clamp Removal, *101*
- USB Front Face, *91*
- User Password, *84*

V

- Vibration and Shocks, *55*